



Product Catalogue



Specialist Manufacturers of EMI/RFI
Screening and Shielding Products

Europe's leading & most trusted manufacturers
interference (RF & EMI) screening products „

A few notes of design for EMC:

We are happy to get involved at any stage of your project however the earlier we're involved, the easier it is for us to find a cost effective solution to your shielding needs. Fitting a solution after your product has failed testing can be unnecessarily expensive and we cannot stress enough the important of designing with EMC in mind from day one.

Please be aware that all material performance results quoted in this publication have been obtained in a test room environment and should be used as a guide. There are many factors that can affect shielding performance in the final product and as such Nolato PPT recommends that customers always test their products to ensure compliance with applicable regulations.

Nolato PPT
Units 12 & 13 Maldon Trade Park
The Causeway
Maldon
Essex
CM9 4JL UK

+44 (0) 1376 550525
sales.ppt@nolato.com
www.nolato.com



Nolato PPT is an ISO9001:2015
registered manufacturer

CONTENTS & PRODUCT OVERVIEW

Knitshield - Knitted Mesh

Pages 4 - 13

KP Shielding

Knitted wire mesh in Monel, Aluminium, Stainless Steel, Brass & Tinned Copper-clad Steel (TCS)

KE Shielding

Knitted wire mesh (types as KP Shielding) with an elastomer core, typically of neoprene or silicone

KC Shielding

"Twinstrip" gaskets provide the high shielding levels of wire mesh with an environmental seal fitted in tandem

KM Shielding

Wire mesh shielding with an aluminium extrusion carrier provides a ready to mount strip or frame

KW Shielding

A knitted mesh bandage in a tubular form

KR Shielding

Compressed mesh rings, washers, glands and gasket seals

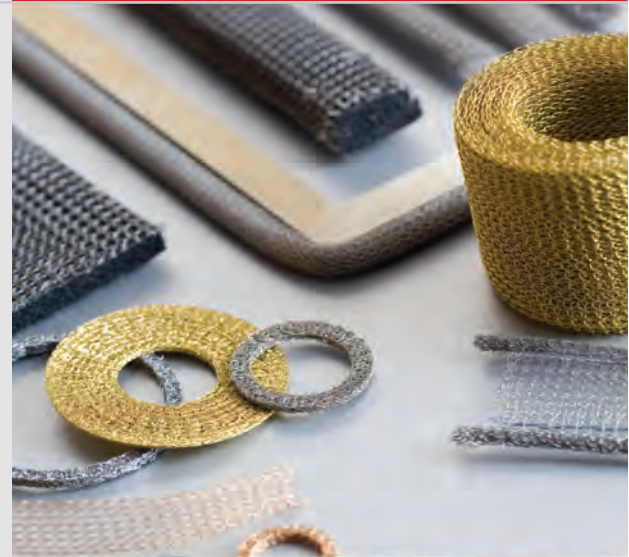

Ventshield - Attenuated Vents

Pages 14 - 19

VH Shielding

A range of honeycomb ventilation panels using an extruded aluminium frame in various styles

VF Shielding

Dust filtration units that can be mounted as separate units or as part of the attenuation vent assembly

VB Shielding

Composites of the VH Shielding honeycomb attenuation vents and demountable dustfilter panels containing a demembrated polyurethane filter

VP Shielding

A high performance range of honeycomb vent panels which are designed for high performance applications such as screened rooms, military applications and shelters

VT Shielding

Thin vents for applications where space is at a premium

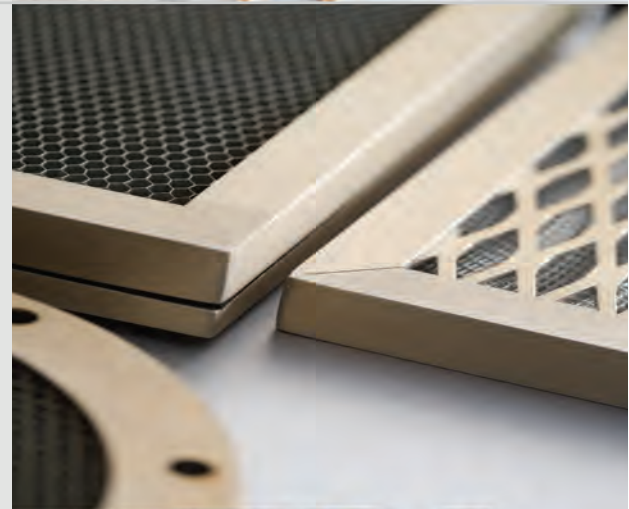

Silshield - Oriented Wires in Silicone

Pages 20 - 22

SP Shielding

Vertically orientated wires bonded into silicone providing around 100 contact points per cm²

SF Shielding

An hydrocarbon resistant fluorosilicone variant of the SP Shielding

SR Shielding

The flame retardant variant of the SP Shielding

SS Shielding

A softer sponge variant

SG Shielding

Flame retardant sponge variant

SE Shielding

Solid silicone with either a fluorosilicone or wire free edge



Winshield - Shielded Windows

Pages 23 - 25

WF Shielding

Windows of laminated glass or plastic construction using a fine wire mesh as the shielding media

WG Shielding

A low cost range of windows offering the same high level of shielding performance as WF Shielding but with edge lamination only

WC Shielding

Mesh gauze moulded into clear plastic

WM Shielding

Woven copper and stainless steel meshes can be supplied for customers to fabricate their own screens



Nolato PPT
Unit 12 Maldon Trade park
The Causeway, Maldon
CM9 4LJ

T: +44 (0)1376 550 525
W: www.p-p-t.co.uk
E: sales.ppt@nolato.com

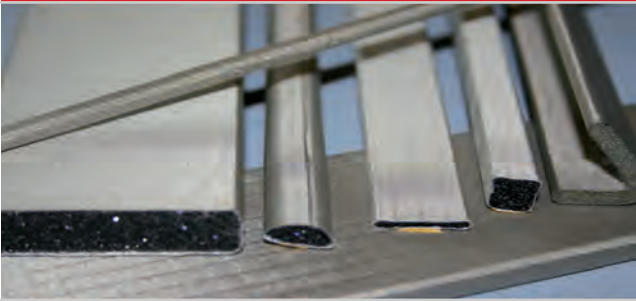

Metweave

Pages 26 - 29

MW Shielding

A range of materials using a sponge core wrapped with a highly conductive impregnated fabric

MF Shielding

A range of highly conductive fabrics

MS Shielding

Conductive sponge between two layers of conductive fabric



Conductive Finger Strips

Pages 30 - 36

CFS Shielding

Available in a wide range of profiles and materials



Shielding Cans

Pages 37 - 38

PCB Shielding

A comprehensive range of standard and custom PCB shielding cans



Exshield - Conductive Silicone

Pages 39 - 42

EC Shielding

Silicone or fluorosilicone with metallic particle filler forming a highly conductive elastomer

ES Shielding

Silicone or fluorosilicone supplied either as sheets or pre-forms and die-cut into gaskets as required



Maxshield - Specialised Materials

Pages 43 - 44

GA Shielding - Aluweave

An ultra thin gasket material comprising 0.4mm woven aluminium mesh filled with a silicone, fluorosilicone or neoprene elastomer

GX Shielding - Monex

Similar to the GA Shielding but using an expanded Monel foil in 0.5 or 0.75mm thicknesses



Conductive Foil Tapes

Page 45

TF Shielding

A range of foil tapes in aluminium or copper



Connector Gaskets

Page 46 - 47

DC Shielding

Includes hand formed and precision die cut gaskets made from a large selection of materials



Conductive Adhesives

Page 48

AS Shielding

A range of one-part conductive particle filled silicone rubber adhesives



Non-conductive Gaskets

Page 49

RS Shielding

Non-conductive gaskets manufactured from a wide range of materials to suit customer applications

Frequently Asked Questions

Pages 50 - 52

'IP' Ratings

Page 53



Nolato PPT
Unit 12 & 14
Maldon Trade Park The
Causeway, Maldon
CM9 4LJ

T: +44 1376 550525 w:
www.p-p-t.co.uk E:
sale.ppt@nolato.com

KNITSHIELD | Knitted Mesh KP Shielding

Applications:

Because knitted wire meshes are not as resilient as elastomer cored meshes (see KE Shielding), and will eventually take a compression-set, they are generally used where the panel mating surfaces are permanent or fixed.

KP meshes provide only limited environmental sealing so are normally used for applications that are not exposed to the elements unless they are protected by a further external elastomeric seal (see KC Shielding). They do, however, have a long service life and a high temperature tolerance.

For optimum effectiveness knitted mesh gaskets should be compressed by 20 – 25% of their relaxed height. If surface irregularities prevent this, an elastomer cored mesh (KE Shielding) would be more suitable.

Gaskets can either be retained in a groove or channel or fixed with adhesive (the wire contact points can penetrate a thin film), welding or soldering. To facilitate clamping or riveting, 'round-with-tail' and 'double-round-with-tail' sections are available.

Specifications:

Monel	- BS3075 – NA13	(0.11mm diameter)
Aluminium 5056	- AMS 4182	(0.13mm diameter)
TCS	- ASTM B520	(0.11mm diameter)
Stainless Steel	- Alloy 304	(0.11mm diameter)

Performance: Typical Attenuation dB

FREQUENCY	FIELD	MONEL	ALUMINIUM	TCS	S/STEEL
10KHz	H	45	40	60	40
100KHz	H	49	45	65	44
1MHz	H	60	60	85	58
1MHz	E	125	125	125	125
10MHz	E	120	120	120	120
100MHz	E	100	100	108	100
400MHz	P	98	95	99	94
1GHz	P	85	76	78	76
10GHz	P	80	65	62	60

Tolerances:

General +0.8mm / -0.0mm on all dimensions

How to order:

Standard sizes can be specified from the tables opposite.

Alternatively, specify:
Series - Wire Code - Style - Size/Dimensions

Examples:

KP-M-10-0024 is Monel wire 2.4 mm diameter round

KP-A-20-0095-0127 is Aluminium wire 9.5 x 12.7 mm rectangular

Knitted wire meshes are produced from a single continuous filament and produce very high levels of EMI shielding performance when evenly compressed between two metallic contact surfaces.

Our KP Shielding meshes are available in four basic wire types – Monel, Aluminium, TCS (Tinned Copper-clad Steel) and Stainless Steel. Each has its own specific characteristics but TCS is generally regarded as the most suitable for EMP (low frequency) shielding.



Nolato PPT
Unit 12 Maldon Trade park
The Causeway, Maldon
CM9 4LJ

T: +44 (0)1376 550 525
W: www.p-p-t.co.uk
E: sales.ppt@nolato.com

SERIES	WIRE CODE	STYLE	SIZE
KP	M=Monel	10=Round	xxxx-xxxx
	A=Aluminium	20=Rectangular	
	T=TCS	30=Round with tail	
	S=Stainless Steel	40= Double round with tail	

KNITSHIELD | Knitted Mesh KP Shielding

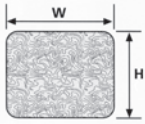

RECTANGULAR

HEIGHT X WIDTH	PART NUMBER
1.57 x 1.57	20-0016-0016
1.57 x 3.18	20-0016-0032
1.57 x 4.75	20-0016-0048
1.57 x 6.35	20-0016-0064
1.57 x 7.92	20-0016-0080
1.57 x 9.53	20-0016-0095
1.57 x 12.7	20-0016-0127
1.57 x 15.9	20-0016-0159
1.57 x 19.1	20-0016-0191
1.57 x 25.4	20-0016-0254
2.36 x 2.36	20-0024-0024
2.36 x 3.18	20-0024-0032
2.36 x 4.75	20-0024-0048
2.26 x 6.35	20-0024-0064
2.36 x 7.92	20-0024-0080
2.36 x 9.53	20-0024-0095
2.36 x 12.7	20-0024-0127
2.36 x 15.9	20-0024-0159
3.18 x 3.18	20-0032-0032
3.18 x 3.96	20-0032-0040
3.18 x 4.75	20-0032-0048
3.18 x 6.35	20-0032-0064
3.18 x 7.92	20-0032-0080
3.18 x 9.53	20-0032-0095
3.18 x 12.7	20-0032-0127
3.18 x 15.9	20-0032-0159
3.18 x 19.1	20-0032-0191
3.18 x 25.4	20-0032-0254
4.75 x 4.75	20-0048-0048
4.75 x 6.35	20-0048-0064
4.75 x 7.92	20-0048-0080
4.75 x 9.53	20-0048-0095
4.75 x 12.7	20-0048-0127
4.75 x 15.9	20-0048-0159
4.75 x 19.1	20-0048-0191
4.75 x 25.4	20-0048-0254
6.35 x 6.35	20-0064-0064
6.35 x 9.53	20-0064-0095
6.35 x 12.7	20-0064-0127
6.35 x 15.9	20-0064-0159
6.35 x 19.1	20-0064-0191
6.35 x 25.4	20-0064-0254
7.92 x 7.92	20-0080-0080
9.53 x 9.53	20-0095-0095
9.53 x 15.9	20-0095-0159



ROUND SECTION

DIAMETER	PART NUMBER
1.57	10-0016
2.36	10-0024
3.18	10-0032
3.96	10-0040
4.75	10-0048
6.35	10-0064
7.92	10-0080
9.53	10-0095
11.1	10-0111
12.7	10-0127

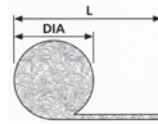

ROUND WITH TAIL

DIA X LENGTH	PART NUMBER
1.57 x 9.53	30-0016-0095
1.57 x 12.7	30-0016-0127
1.57 x 15.9	30-0016-0159
2.36 x 12.7	30-0024-0127
2.36 x 15.9	30-0024-0159
3.18 x 12.7	30-0032-0127
3.18 x 15.9	30-0032-0159
3.18 x 19.1	30-0032-0191
3.96 x 12.7	30-0040-0127
3.96 x 19.1	30-0040-0191
4.75 x 15.9	30-0048-0159
4.75 x 19.1	30-0048-0191
4.75 x 25.4	30-0048-0254
6.35 x 15.9	30-0064-0159
6.35 x 19.1	30-0064-0191
6.35 x 25.4	30-0064-0254
7.92 x 15.9	30-0080-0159
7.92 x 19.1	30-0080-0191
7.92 x 25.4	30-0080-0254
9.53 x 15.9	30-0095-0159
9.53 x 19.1	30-0095-0191
9.53 x 25.4	30-0095-0254
11.1 x 19.1	30-0111-0191
11.1 x 25.4	30-0111-0254
12.7 x 19.1	30-0127-0191
12.7 x 25.4	30-0127-0254

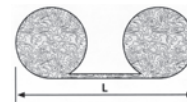

TWIN ROUND WITH TAIL

DIA X LENGTH	PART NUMBER
1.57 x 9.53	40-0016-0095
1.57 x 12.7	40-0016-0127
1.57 x 15.9	40-0016-0159
2.36 x 12.7	40-0024-0127
3.18 x 9.53	40-0032-0095
3.18 x 12.7	40-0032-0127
3.18 x 15.9	40-0032-0159
4.75 x 15.9	40-0048-0159
4.75 x 19.1	40-0048-0191
4.75 x 25.4	40-0048-0254
6.35 x 15.9	40-0064-0159
6.35 x 19.1	40-0064-0191
6.35 x 25.4	40-0064-0254
9.53 x 25.4	40-0095-0254

Please note:

- Knitted meshes are available in continuous lengths, cut pieces or as fabricated gaskets
- Compressed mesh gaskets and O-rings can be produced to customers specifications - see KR Shielding.
- Other sizes are available – please ask!

For details of fixing methods or any technical queries please contact our sales office.



Nolato PPT
Unit 12 & 14
Maldon Trade Park The
Causeway, Maldon
CM9 4LJ

T: +44 1376 550525 w:
www.p-p-t.co.uk E:
sale.ppt@nolato.com

KNITSHIELD | Knitted Mesh KE Shielding

Applications:

In comparison with 'solid' mesh types, elastomer-cored knitted wire meshes have a high degree of recovery so they are more suitable for use on doors and covers that are regularly opened and closed. The closing pressure is much lower and a good EMI shield is formed even where there are minor surface irregularities. KE gaskets will also provide limited environmental sealing, particularly against dust. Where there are hazardous conditions fluorosilicone or other special formulations can be specified to meet your requirements.

Elastomer-cored knitted wire mesh gaskets can either be retained in a groove or channel or fixed with adhesive (the wire contact points can penetrate a thin film). To facilitate clamping or riveting, 'round-with-tail' and 'double-round-with-tail' sections are available. Many KE Shielding cross-sections are available with a pressure sensitive adhesive backing applied across part of one face for easy fitting.

Alternative fixing methods use tandem or 'Twinstrip' environmental seals (see KC Shielding) or round-with-tail mesh pre-fitted into aluminium mounting frames (see KM Shielding), which can be pre-drilled for easy fitting.

Specifications:

Monel	- BS3075 – NA13	(0.11mm diameter)
Aluminium 5056	- AMS 4182	(0.13mm diameter)
TCS	- ASTM B520	(0.11mm diameter)
Stainless Steel	- Alloy 304	(0.11mm diameter)
Silicone Sponge	- AMS 3195	
Silicone Solid/Tube	- ZZ-R-765	
Neoprene Solid/Tube	- Mil-R-6855	

Performance: Typical Attenuation dB

FREQUENCY	FIELD	MONEL	ALUMINIUM	TCS	S/STEEL
10KHz	H	45	40	60	40
100KHz	H	49	45	65	44
1MHz	H	60	60	85	58
1MHz	E	125	125	125	125
10MHz	E	120	120	120	120
100MHz	E	100	100	108	100
400MHz	P	98	95	99	94
1GHz	P	85	76	78	76
10GHz	P	80	65	62	60

Tolerances:

General - $\pm 0.8\text{mm}$ on all dimensions

Our KE Shielding elastomer-cored knitted wire meshes consist of two layers of knitted wire over a low-closing-force rubber or elastomer core and offer almost the same shielding effectiveness as all-mesh types.

In some cases a single mesh layer will be sufficient but in extreme cases, such as EMP, up to seven layers of TCS will be used. Cored knitted mesh is sometimes combined with an environmental seal to provide IP ratings of 65 or above, depending on the materials used and the suitability of the mating surfaces (see KC Shielding).

The core materials are usually sponges (neoprene, silicone, EPDM or PU) although for many applications a silicone or neoprene tube can be specified.



Nolato PPT
Unit 12 Maldon Trade park
The Causeway, Maldon
CM9 4LJ

T: +44 (0)1376 550 525
W: www.p-p-t.co.uk
E: sales.ppt@nolato.com

SERIES	WIRE CODE	ELASTOMER	STYLE	SIZE
KE	M=Monel	SS=Silicone Sponge	60=Round	xxxx-xxxx
	A=Aluminium	ST=Silicone Tube	70=Rectangular	
	T=TCS	NS=Neoprene Sponge	80=Round with tail	
	S=Stainless Steel	NT=Neoprene Tube	90= Double round with tail	
		SX=Solid Silicone		
		NX= Solid Neoprene		
		PU=Polyurethane Foam		

KNITSHIELD | Knitted Mesh KE Shielding



ROUND SECTION

OUTSIDE DIA X INSIDE DIA	PART NUMBER
1.57 x -----	60-0016
2.36 x -----	60-0024
3.18 x 1.57	60-0032-0016
4.75 x 3.18	60-0048-0032
6.35 x 3.18	60-0064-0032
7.92 x 4.75	60-0080-0048
9.53 x 6.35	60-0095-0064
11.1 x 7.92	60-0111-0080
12.7 x 9.53	60-0127-0095
14.9 x 11.1	60-0149-0111
19.1 x -----	60-0191
25.4 x -----	60-0254

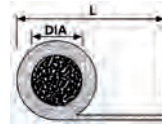

ROUND WITH TAIL

DIA X LENGTH	PART NUMBER
1.57 x 12.7	80-0016-0127
1.57 x 15.9	80-0016-0159
1.57 x 19.1	80-0016-0191
2.36 x 12.7	80-0024-0127
2.36 x 19.1	80-0024-0191
3.18 x 12.7	80-0032-0016-0127
3.18 x 15.9	80-0032-0016-0159
3.18 x 19.1	80-0032-0016-0191
3.96 x 12.7	80-0040-0127
3.96 x 19.1	80-0040-0191
4.75 x 12.7	80-0048-0032-0127
4.75 x 15.9	80-0048-0032-0159
4.75 x 19.1	80-0048-0032-0191
4.75 x 25.4	80-0048-0032-0254
6.35 x 12.7	80-0064-0048-0127
6.35 x 15.9	80-0064-0048-0159
6.35 x 19.1	80-0064-0048-0191
6.35 x 25.4	80-0064-0048-0254
9.53 x 19.1	80-0095-0064-0191
9.53 x 25.4	80-0095-0064-0254

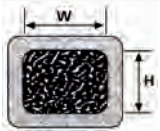

RECTANGULAR

HEIGHT X WIDTH	PART NUMBER
2.36 x 3.18	70-0024-0032
2.36 x 4.78	70-0024-0048
2.36 x 6.35	70-0024-0064
3.18 x 3.18	70-0032-0032
3.18 x 4.78	70-0032-0048
3.18 x 6.35	70-0032-0064
3.18 x 9.53	70-0032-0095
3.18 x 12.7	70-0032-0127
4.78 x 4.78	70-0048-0048
4.78 x 6.35	70-0048-0064
4.78 x 9.53	70-0048-0095
6.35 x 6.35	70-0064-0064
6.35 x 9.53	70-0064-0095
6.35 x 12.7	70-0064-0127

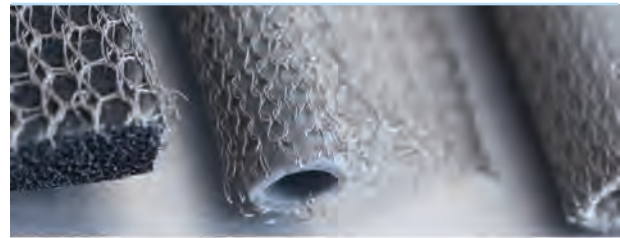

TWIN ROUND WITH TAIL

DIA X LENGTH	PART NUMBER
3.18 x 9.53	90-0032-0016-0095
3.18 x 12.7	90-0032-0016-0127
3.18 x 15.9	90-0032-0016-0159
4.75 x 15.9	90-0048-0032-0159
4.75 x 19.1	90-0048-0032-0191
4.75 x 25.4	90-0048-0032-0254
6.35 x 15.9	90-0064-0032-0159
6.35 x 19.1	90-0064-0032-0191
6.35 x 25.4	90-0064-0032-0254
9.53 x 25.4	90-0095-0064-0254

Please note:

- Knitted meshes are available in continuous lengths, cut pieces or as fabricated gaskets
- The above are examples of standard profiles and sizes that we offer - other sizes are available - please ask!

For details of fixing methods or any technical queries please contact our sales office.

How to order:

Standard sizes can be specified from the tables opposite. Alternatively, specify:

Series - Wire Code - Elastomer - Style-Size/Dimensions

Examples:

KE-MST-60-0024 is 2.4 mm diameter round 2 x Monel layers over silicone tube
KE-ANS-70-0032-0095-(1) S/A is 3.2 x 9.5 mm rectangular neoprene sponge with 1 x Aluminium mesh layer and PSA backing

Notes:

- Suffix #1= number of layers.
E.g. (1) indicates one layer, default is 2 layers
- S/A = Self-adhesive
- N/A = No adhesive
- Adhesive cannot be used on more than one layer



Nolato PPT
Unit 12 & 14
Maldon Trade Park The
Causeway, Maldon
CM9 4LJ

T: +44 1376 550525 w:
www.p-p-t.co.uk E:
sale.ppt@nolato.com

KNITSHIELD | Twinstrip KC Shielding

Twinstrip is a combination of knitted or cored mesh gasket with a non-conductive environmental seal. The wire mesh types used are Monel, Aluminium, TCS and Stainless Steel and the permutations of wire and elastomer combinations are almost endless providing a wide range of environmental, water, dust and pressure seals.

KC materials can be supplied as gaskets, in strip form or as pre-cut kits, ready bagged and labelled to suit specific enclosures. Limit stops and collars can be fitted to prevent over-compression or the distortion of mating surfaces.

Applications:

Twinstrip is used on enclosure doors and covers where an environmental or high IP rated seal is needed in addition to an EMI gasket. The materials provide the shielding levels of knitted mesh combined with the environmental protection of sponge, tubular or solid rubbers. For hazardous situations, such as the presence of hydrocarbon contamination, fluorosilicone or other chemical resistant elastomers can be used.

Most Twinstrip has a pressure sensitive adhesive backing with release tape, enabling the gaskets to be quickly and easily fixed in position. The adhesive also helps unmounted gaskets to retain their shape during production and storage and allows the gaskets to be mounted onto any flat surface without the need for a groove or channel to hold it in place.

For many applications, particularly where the gasket is fitted inside a rack or enclosure, pre-cut and mitred adhesive backed lengths of Twinstrip can be supplied to your specification, offering a fast and effective solution that reduces material costs and packaging.

Specifications:

Monel	- BS3075 – NA13	(0.11mm diameter)
Aluminium 5056	- AMS 4182	(0.13mm diameter)
TCS	- ASTM B520	(0.11mm diameter)
Stainless Steel	- Alloy 304	(0.11mm diameter)
Silicone Sponge	- AMS 3195	
Silicone Solid	- ZZ-R-765	
Neoprene Songe	- Mil-R-6130	
Neoprene Solid	- Mil-R-6855	

Performance: Typical Attenuation dB

FREQUENCY	FIELD	MONEL	ALUMINIUM	TCS	S/STEEL
10KHz	H	45	40	60	40
100KHz	H	49	45	65	44
1MHz	H	60	60	85	58
1MHz	E	125	125	125	125
10MHz	E	120	120	120	120
100MHz	E	100	100	108	100
400MHz	P	98	95	99	94
1GHz	P	85	76	78	76
10GHz	P	80	65	62	60

Tolerances:

- Wire meshes - generally $\pm 0.8\text{mm}$ on diameter, width and height
- Linear measurements on gaskets - up to $300\text{mm} \pm 0.8\text{mm}$, up to $1000\text{mm} \pm 1.5\text{mm}$
- Sponge and solid elastomers - up to $4.5\text{mm} \pm 0.4\text{mm}$, over $4.5\text{mm} \pm 0.8\text{mm}$



Nolato PPT
Unit 12 Maldon Trade park
The Causeway, Maldon
CM9 4LJ

T: +44 (0)1376 550 525
W: www.p-p-t.co.uk
E: sales.ppt@nolato.com



KNITSHIELD | Twinstrip

KC Shielding

TWINSTRIP CONFIGURATIONS

STANDARD

ROUND MESH OR
CORED MESH AND
CARRIER WITH PSA

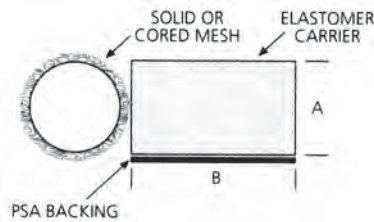

STANDARD

SQUARE MESH OR
CORED MESH AND
CARRIER WITH PSA

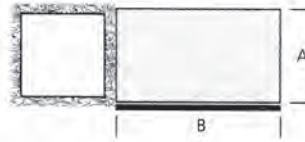

SOFT 'P' SEAL*

SOFT 'P' SECTION
S/A EPDM SPONGE
WITH TUBE CORE
MESH SECTION



DOUBLE*

TWO MESH SECTIONS
OF MESH AND PLAIN
RUBBER/TUBE AND
CARRIER WITH PSA



*According to customers specifications or drawings

*According to customers specifications or drawings

Base Part Numbers for Standard Sizes of Elastomer Carrier

A X B	PART NUMBER
1.6 x 3.2	0016-0032
1.6 x 9.5	0016-0095
1.6 x 12.7	0016-0127
1.6 x 15.9	0016-0159
2.4 x 9.5	0024-0095
2.4 x 12.7	0024-0127
2.4 x 19.1	0024-0191
3.2 x 4.8	0032-0048
3.2 x 6.4	0032-0064
3.2 x 9.5	0032-0095
3.2 x 12.7	0032-0127
3.2 x 15.9	0032-0159
3.2 x 19.1	0032-0191
4.8 x 4.8	0048-0048
4.8 x 6.4	0048-0064
4.8 x 9.5	0048-0095

A X B	PART NUMBER
4.8 x 12.7	0048-0127
4.8 x 15.9	0048-0159
4.8 x 19.1	0048-0191
6.4 x 6.4	0064-0064
6.4 x 9.5	0064-0095
6.4 x 12.7	0064-0127
6.4 x 15.9	0064-0159
6.4 x 19.1	0064-0191
9.5 x 6.4	0095-0064
9.5 x 9.5	0095-0095
9.5 x 12.7	0095-0127
9.5 x 19.1	0095-0191
9.5 x 25.4	0095-0254

Continuous lengths are 10 metres and rolled unless otherwise specified

Please note:

- Rubber gaskets change shape marginally after cutting as the rubber recovers. This should be taken into account when inspecting pre-cut gasket forms
- Twinstrip can be supplied as strip material, pre-formed gasket sections or as finished gaskets

- Maximum length for strip material is 10 metres
- Other sizes are available – please ask!

For details of fixing methods or any technical queries please contact our sales office.

How to order:

Standard sizes can be specified from the table above. Alternatively, specify:

Series - Mesh portion - Elastomer - Size/Dimensions

Example:

KC-MST-60-0032(1)-NS-0032-0127-S/A = Monel mesh (1 layer) over 3.2 diameter Silicone tube bonded to Neoprene sponge 3.2 x 12.7 mm rectangular section (self-adhesive)

Notes:

- Suffix #1 (after mesh portion) = number of layers of mesh, E.g. (1) indicates one layer, default is 2 layers
- S/A = Self-adhesive (default is S/A)
- N/A= No adhesive.

For gaskets or strip material not shown, please send a drawing or specification and we will allocate a part number with our quotation

SERIES	MESH PORTION	ELASTOMER	SIZE/DIMENSION OF ELASTOMER
KC	M=Monel	SS=Silicone Sponge	xxxx-xxxx
	A=Aluminium	NS=Neoprene Sponge	
	T=TCS	NX=Neoprene Solid	
	S=Stainless Steel	SX=Silicone Solid	
		ES=EPDM Sponge	



Nolato PPT
Unit 12 & 14
Maldon Trade Park The
Causeway, Maldon
CM9 4LJ

T: +44 1376 550525 w:
www.p-p-t.co.uk E:
sale.ppt@nolato.com

KNITSHIELD | Knitted Mesh with Carrier

KM Shielding

KM Shielding gasket strip and frame materials consist of a slotted aluminium extrusion carrier into which a solid or elastomer cored knitted mesh gasket is clamped. These ready-to-fit, semi-rigid gasket profiles help to avoid the problems often encountered when fitting adhesive-backed or plain mesh gaskets.

They can be supplied with dual gaskets, one on either side of the carrier, with one being a mesh gasket and the other an environmental seal. The aluminium extrusion acts as a limit stop, controlling the even compression of the gasket.

Applications:

KM Shielding gaskets can be used on covers, door frames and other apertures where the surrounding metalwork is either insufficiently rigid or is very heavy duty and needs a robust, well anchored gasket which will not be affected by the stresses and shearing action imposed on conventional twinstrip gaskets.

KM mesh is generally supplied as straight lengths (up to 3m), as welded/jointed frames to suit specific apertures or as mitre cut sections ready to mount around cabinets, doors or hatches. The aluminium carrier is usually drilled and countersunk ready for screws or rivets or, in less stringent conditions, frames can be fixed using a high-bond pressure sensitive adhesive. Welding is possible but not recommended as damage to the mesh or elastomer is very difficult to repair.

Specifications:

Monel	- BS3075 – NA13	(0.11mm diameter)
Aluminium 5056	- AMS 4182	(0.13mm diameter)
TCS	- ASTM B520	(0.11mm diameter)
Stainless Steel	- Alloy 304	(0.11mm diameter)
Silicone Sponge	- AMS 3195	
Silicone Solid	- ZZ-R-765	
Neoprene Sponge	- Mil-R-6130	
Neoprene Solid	- Mil-R-6855	
Aluminium carrier	- BS1474 6063 with Alochrom 1000, 1200 or Iridite, a RoHS compliant surface treatment	

Performance: Typical Attenuation dB

FREQUENCY	FIELD	MONEL	ALUMINIUM	TCS	S/STEEL
10KHz	H	45	40	60	40
100KHz	H	49	45	65	44
1MHz	H	60	60	85	58
1MHz	E	125	125	125	125
10MHz	E	120	120	120	120
100MHz	E	100	100	108	100
400MHz	P	98	95	99	94
1GHz	P	85	76	78	76
10GHz	P	80	65	62	60

Tolerances:

- Wire meshes - generally $\pm 0.8\text{mm}$ on diameter, width and height
- Linear measurements on gaskets - up to 300mm $\pm 0.8\text{mm}$, up to 1000mm $\pm 1.5\text{mm}$
- Sponge and solid elastomers - up to 4.5mm $\pm 0.4\text{mm}$, over 4.5mm $\pm 0.8\text{mm}$



Nolato PPT
Unit 12 Maldon Trade park
The Causeway, Maldon
CM9 4LJ

T: +44 (0)1376 550 525
W: www.p-p-t.co.uk
E: sales.ppt@nolato.com



KNITSHIELD | Knitted Mesh with Carrier

KM Shielding

SINGLE SLOT STYLE

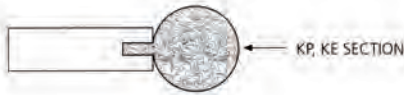

TWIN SLOT STYLE

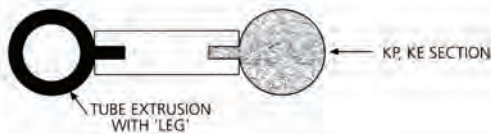
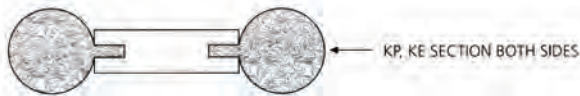

WITH ENVIRONMENTAL SEAL

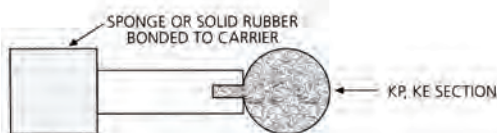

Please note:

- Avoid mounting any 'dual' or 'twin' gasket material where two materials are bonded together in a position where the normal process of closing a door cover exerts a stress or shearing action which creates pressure on the joint between the two materials. If possible, the pressure exerted on any gasket should be directly downwards onto the exposed face of the gasket.
- KM Shielding gasket forms can be supplied as strip material, pre-formed gasket sections or as ready-to-mount finished gaskets.
- Other sizes are available – please ask!

For details of fixing methods or any technical queries please contact our sales office.

SERIES KM CARRIER SIZES

Shape	Thickness mm	Width mm	Slots
CS1	3.2	9.5	1
CS2	3.2	12.7	1
CS3	3.2	15.9	1
CS4	3.2	19.1	1
CS6	3.2	12.7	2

How to order:

Standard sizes can be specified from the table above. Alternatively, specify:
 Series - Carrier - Mesh portion - Elastomer portion (where applicable) - Elastomer Size

Examples:

KM-CS6-M-10-0064-ST-0064-0048 indicates a base material comprising carrier section CS6 with 6.4 mm diameter Monel mesh fixed to one side and a silicone rubber tube 6.4 mm o.d. and 4.8mm i.d. on the opposing side.
 KM-CS1-ASS-60-0048 indicates a base carrier section CS1 with an aluminium mesh covered silicone sponge gasket 4.8 mm diameter on one side only.

Notes:

- If second gasket/seal on CS6 is not specified, it defaults to being the same as the first material.
- If a suffix in brackets is shown after the mesh part number this indicates the number of mesh layers. The default is two (2) layers and does not need to be specified.

SERIES	CARRIER	MESH PORTION	ELASTOMER	SIZE / DIMENSIONS OF ELASTOMER
KM	CS1	M=Monel	SS=Silicone Sponge	xxxx-xxxx
	CS2	A=Aluminium	NS=Neoprene Sponge	
	CS3	T=TCS	ST=Silicone Tube*	
	CS4	S=Stainless Steel		
	CS6			*= with 'leg' for twin slot carriers

For gaskets or strip material not shown, or specific shapes, made up frames and fixing hole positions, please send a drawing and we will allocate a part number with our quotation.



Nolato PPT
 Unit 12 & 14
 Maldon Trade Park The
 Causeway, Maldon
 CM9 4LJ

T: +44 1376 550525 w:
 www.p-p-t.co.uk E:
 sale.ppt@nolato.com

KNITSHIELD | Knitted Mesh KW Shielding

KW Shielding knitted mesh bandage is a tubular form knitted stocking supplied in flat tape form. They are available in four basic wire types – Monel, Aluminium, TCS (Tinned Copper-clad Steel) and Stainless Steel.



Applications:

Knitted mesh tapes are generally used to wrap cable forms, wiring systems or conduit to provide a high integrity 4-layer screen, which, if adequately grounded, can greatly reduce radiated interference.

The tape is a nominal 0.4mm thick and should be spirally overlapped by 50% to provide full screening effectiveness. Each end should be soldered or clamped, avoiding twisting into a 'pigtail' which could effectively become an antenna.

Specifications:

Monel	- BS3075 – NA13	(0.11mm diameter)
Aluminium 5056	- AMS 4182	(0.13mm diameter)
TCS	- ASTM B520	(0.11mm diameter)
Stainless Steel	- Alloy 304	(0.11mm diameter)

Performance: Typical Attenuation dB

FREQUENCY	FIELD	MONEL	ALUMINIUM	TCS	S/STEEL
10KHz	H	45	40	60	40
100KHz	H	49	45	65	44
1MHz	H	60	60	85	58
1MHz	E	125	125	125	125
10MHz	E	120	120	120	120
100MHz	E	100	100	108	100
400MHz	P	98	95	99	94
1GHz	P	85	76	78	76
10GHz	P	80	65	62	60

Tolerances:

± 2mm on width

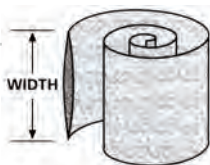

How to order:

Standard sizes can be specified from the table opposite.

Example:

KW-A-55-0127 is Aluminium mesh tape 12.7 mm wide

SERIES	WIRE CODE	STYLE	SIZE
KW	M=Monel	55 (flat tape)	0127 (12.7mm)
	A=Aluminium		0254 (25.4mm)
	T=TCS		0508 (50.8mm)
	S=Stainless Steel		



Nolato PPT
Unit 12 Maldon Trade park
The Causeway, Maldon
CM9 4LJ

T: +44 (0)1376 550 525
W: www.p-p-t.co.uk
E: sales.ppt@nolato.com



KR Shielding compressed mesh washers, gaskets and seals utilise knitted mesh formed under pressure into resilient high density profiles.

KNITSHIELD | Knitted Mesh KR Shielding

Applications:

Compressed knitted mesh profiles are used as gland rings, grounding buttons, magnetron seals and numerous other applications where a high density mesh is required.

Each application will be individual and related to the specific and mechanical properties of the gasket so please contact us to discuss your requirements.

Specifications:

Monel	- BS3075 – NA13	(0.11mm diameter)
Aluminium 5056	- AMS 4182	(0.13mm diameter)
TCS	- ASTM B520	(0.11mm diameter)
Stainless Steel	- Alloy 304	(0.11mm diameter)



Performance: Typical Attenuation dB

FREQUENCY	FIELD	MONEL	ALUMINIUM	TCS	S/STEEL
10KHz	H	45	40	60	40
100KHz	H	49	45	65	44
1MHz	H	60	60	85	58
1MHz	E	125	125	125	125
10MHz	E	120	120	120	120
100MHz	E	100	100	108	100
400MHz	P	98	95	99	94
1GHz	P	85	76	78	76
10GHz	P	80	65	62	60

Tolerances:

± 0.5mm on width

How to order:

Specify series KR, wire type and describe your component by its outside and inside diameters plus thickness (if an 'o' ring) or by means of a drawing if a formed gasket or profile section.

Example:

KR-S-50-0254-0159-0032 is a Stainless Steel washer 25.4 x 15.9 x 3.2mm

For further details on how to specify, please contact us.

SERIES	WIRE CODE	STYLE	SIZE (or) DRAWING NO.
KR	M=Monel A=Aluminium T=TCS S=Stainless Steel	50 (ring)	xxxx-xxxx (or) xxxx-xxxx



Nolato PPT
Unit 12 & 14
Maldon Trade Park The
Causeway, Maldon
CM9 4LJ

T: +44 1376 550525 w:
www.p-p-t.co.uk E:
sale.ppt@nolato.com

VENTSHIELD | Attenuation Vents

VH Shielding

Applications:

Lightweight aluminium honeycomb vents can be mounted onto most forms of shielded enclosure where airflow is needed, either over cooling fans or by convection. They can be mounted anywhere on the enclosure and can be fitted with protective 'kick-plates' to protect the honeycomb material from accidental damage.

Where they may be exposed to the elements the vents can be fitted with 'slant' honeycomb which provides a downward facing aperture, preventing the ingress of rainwater. This has the added benefits of directional airflow and increased attenuation due to the higher aspect-ratio of the cell structure.

Honeycomb ventilation panels are usually supplied with gaskets in a ready-to-mount form which either fits around the aperture in the equipment (non-flanged style) or to be inset into the enclosure (flanged style). Depending on the performance requirements for the application, they can be mounted by bolting through clearance holes in the frame or through the use of captive threaded inserts.

Aluminium honeycomb material is formed by expanding a bonded aluminium foil into a honeycomb structure. This process, which is common to all honeycomb manufacturers, produces a material which is 'polarised' and is conductive either horizontally or vertically. To overcome polarisation problems two layers of honeycomb, mounted at 90 degrees to each other, are used. Please contact us for further information about polarisation.

Each cell in an attenuation vent acts as a waveguide and its performance is a function of its width/height and the ratio between the depth and width of the cell. Generally an aspect ratio of 4:1 or 5:1 is used.

Aluminium honeycomb vents are finished to suit specific applications and can be protected by Alocrom 1000, 1200 or electroplating. We can also offer an Iridite conversion which is RoHS compliant.

Specifications:

For gasket material specifications please refer to knitted mesh gaskets (pages 4-13), oriented wires in silicone gaskets (pages 20-22) and conductive silicone gaskets (pages 39-42).

Performance: Typical Attenuation dB

FREQUENCY	FIELD	ATTENUATION
10 KHz	H	45
100 KHz	H	49
1 MHz	H	51
1 MHz	E	>100
10 MHz	E	>100
100 MHz	E	>100
1 GHz	P	98
10 GHz	P	95

Our VH Shielding range of lightweight aluminium honeycomb attenuating ventilation panels comprise of forms of conductive airflow media retained within an aluminium extrusion. They are designed for use in racks and other forms of commercial enclosure.



Nolato PPT
Unit 12 Maldon Trade park
The Causeway, Maldon
CM9 4LJ

T: +44 (0)1376 550 525
W: www.p-p-t.co.uk
E: sales.ppt@nolato.com

VENTSHIELD | Attenuation Vents VH Shielding

Tolerances:

Overall dimensions ± 0.8mm
Fixing holes/fasteners ± 0.5mm with jigs +/- 0.2mm

Dust filtration

Demountable dust filters are available for use with attenuation vents and are featured in the VB Shielding section. They are generally produced using the AF1 or AF5 frame style and can be mounted with quick-release fasteners for ease of cleaning or replacement.

VH AF1

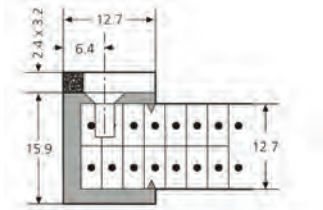

VH AF2

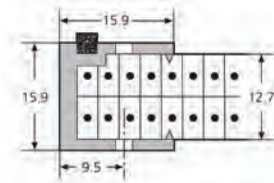

VH AF3

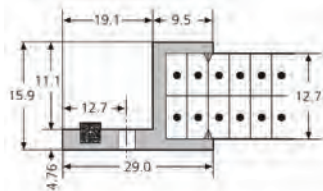

VH AF4

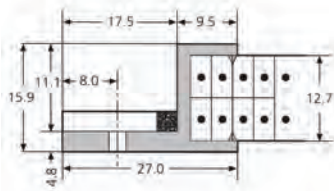

VH AF5

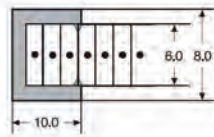

VH AF6

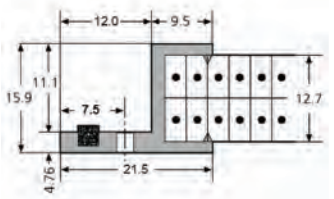

VH AF7

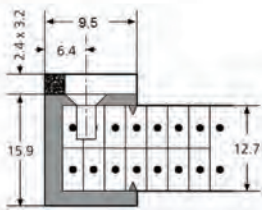

VH AF8

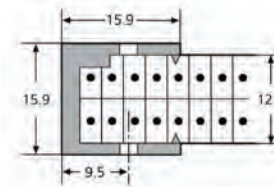

VH AF9

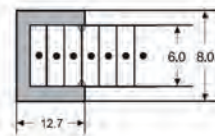

How to order:

Specify: Series - Frame Style - Vent Media - Overall Size - Number of Fixings - Fixing Type/Size

Where possible please provide a detailed drawing.

Example:

VH-AF1-01-2260-4330-12-T/H (4.8) specifies an aluminium cross-polarised vent panel in AF1 frame style with 12 through holes of 4.8 mm diameter. Hole positions to be agreed with the customer prior to manufacture or as shown on the customer drawing.

SERIES	FRAME STYLE	VENT MEDIA	OVERALL SIZE	FIXINGS (NO.)	FIXING TYPE
VH-Vent	AF1	01=Cross-pole	xxxx-xxxx	xx	C/T=Captive insert
Aluminium	AF2	02=Single layer			T/H=Through hole
	AF3	03=Slant 45°			
	AF4	04=Slant cross-pole			
	AF5				
	AF6				
	AF7				
	AF8				
	AF9				

For aluminium vent panel types and styles not shown please contact us or forward a detailed drawing for quotation.



Nolato PPT
Unit 12 & 14
Maldon Trade Park The
Causeway, Maldon
CM9 4LJ

T: +44 1376 550525 w:
www.p-p-t.co.uk E:
sale.ppt@nolato.com

VENTSHIELD | Air Filter with Dustshield VF Shielding

Our VF Shielding combines the benefits of an attenuation vent panel with the properties of a dust filter in a single frame, unlike VB Shielding which utilises separate units fixed together in-situ.

Standard frame styles are AF1, AF2, AF3, AF4, AF6, AF7 and AF8 and they incorporate a triple layer of woven and corrugated aluminium mesh. Each layer has a slightly different degree of corrugation and so provides separation and increased airflow potential. To enable it to perform its dual function the VF filter material is relatively dense and so requires an assisted airflow to operate correctly. A 'kick plate' is built into the unit to protect the filter from damage.

Applications:

Aluminium mesh dust filters are mounted in the same manner as the VH Shielding and are used in industrial or military environments where a 'heavy duty' attenuating dust filter is required and a lighter weight de-membrated polyurethane VB Shielding is not suitable. They are not designed for pure convection and need a driven airflow. They may be solvent cleaned after removal but particular attention should be paid to the replacement of gaskets which could be affected by compression-set or hydrocarbon/solvent contamination.

Specifications:

Woven Aluminium Screen

AMS-4182

Performance: Typical dB

(based on a 250mm² test section)

FREQUENCY	FIELD	ATTENUATION
10KHz	H	42
100KHz	H	53
1MHz	H	61
1MHz	E	92
10MHz	E	81
100MHz	E	60
1GHz	P	52
10GHz	P	43

Tolerances:

Overall dimensions	±0.8mm
Fixing holes/fasteners	±0.5mm with jigs ±0.2mm

How to order:

Specify: *Series - Frame Style - Vent Media - Overall Size - Number of Fixings - Fixing Type/Size*

Where possible please provide a detailed drawing.

Example:

VF-AF1-08-2260-4330-12-T/H (4.8) specifies a corrugated three layer aluminium woven mesh dust-filter in an AF1 style frame with 12 through holes of 4.8 mm diameter. The hole positions would be agreed with the customer prior to manufacture or as shown on the customer drawing.



VF AF2

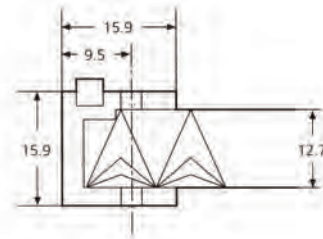

VF AF4

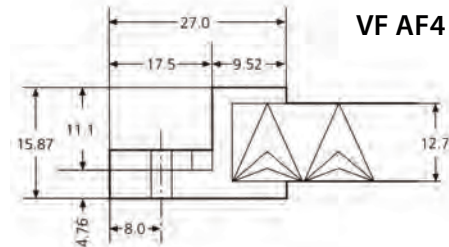

SERIES	FRAME STYLE	VENT MEDIA	OVERALL SIZE	FIXINGS (NO.)	FIXING TYPE
VF-Dust Filter	AF1	08=Triple mesh	xxxx-xxxx	xx	C/T=Captive insert
Aluminium	AF2				T/H=Through hole
	AF3				
	AF4				
	AF6				
	AF7				
	AF8				



Nolato PPT
Unit 12 Maldon Trade park
The Causeway, Maldon
CM9 4LJ

T: +44 (0)1376 550 525
W: www.p-p-t.co.uk
E: sales.ppt@nolato.com

Our VB Shielding vent/filter assemblies are composites of the VH Shielding honeycomb attenuation vents and demountable dust filter panels containing demembrated polyurethane filter media. The vent is specified in the normal way and contains, within its mounting frame, additional fixings (usually captive threaded inserts) which are used to retain the framed dust filter element.

The dust filter can be mounted either side of the vent panel and attention should be paid when specifying the type of interface gasket to ensure that, where necessary, it is conductive. The filter material is available with openings of 30 to 60 pores per inch as standard, but others can be specified, and is secured by a woven mesh kick plate.



VENTSHIELD | Vent/Filter Composites VB Shielding

Applications:

Honeycomb vent & demembrated polyurethane dust filter panels are usually used inside racks and electronic equipment enclosures, in particular where the ingress of dust or foreign matter is likely but the heavier duty woven aluminium mesh is not needed. Filters fitted inside the equipment can have quick-release fastenings and do not require a shielded gasket. In applications where the attenuation vent is fixed directly to the enclosure, dust filters mounted outside the equipment do not need a shielded gasket.

Specifications:

For gasket material specifications please refer to knitted mesh gaskets (pages 4-13), oriented wires in silicone gaskets (pages 20-22) and conductive silicone gaskets (pages 39-42).

VB AF1 DUSTFILTER

AF1
HONEYCOMB
VENT

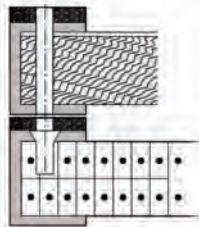

VB AF1 DUSTFILTER

AF1
HONEYCOMB
VENT

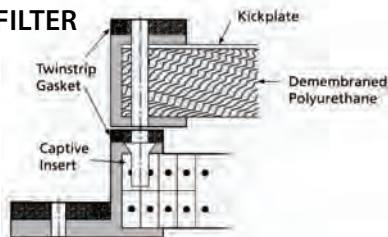

Performance: Typical dB

FREQUENCY	FIELD	ATTENUATION
10 KHz	H	45
100 KHz	H	49
1 MHz	H	51
1 MHz	E	>100
10 MHz	E	>100
100 MHz	E	>100
1 GHz	P	98
10 GHz	P	95

Tolerances:

Overall dimensions	±0.8mm
Fixing holes/fasteners	±0.5mm with jigs ±0.2mm

How to order:

Specify: *Series - Frame Style - Vent Media - Overall Size - Number of Fixings - Fixing Type/Size*

Where possible please provide a detailed drawing.

Example:

VH-AF1-01-2260-4330-12-T/H (4.8) plus VB-AF1-09-6 specifies an AF1 style honeycomb vent fitted with an AF1 dust-filter using 6 fasteners. It would be normal in such instances for the assembly to be detailed in drawing form indicating the precise mounting method and sequence in relation to the enclosure.

SERIES	FRAME STYLE	VENT MEDIA	OVERALL SIZE	FIXINGS (NO.)	FIXING TYPE
VB=Composite	AF1	09=	xxxx-xxxx	xx	As Specified
	AF2	Demembrated			
	AF5	Polyurethane			



Nolato PPT
Unit 12 & 14
Maldon Trade Park The
Causeway, Maldon
CM9 4LJ

T: +44 1376 550525 w:
www.p-p-t.co.uk E:
sale.ppt@nolato.com

VENTSHIELD | High Performance Vent/Filter Composites VP Shielding

Our VP Shielding honeycomb ventilation panels can be custom manufactured from steel, brass or stainless steel. When selecting the material, corrosion resistance relevant to the application environment should be considered along with the attenuation requirements.

Typical construction styles are shown in figures A & B (other styles are available). Typical attenuation figures for the material types and thickness options are shown below. Both rectangular and circular styles are available. Various plating and gasket options are available and should be discussed at the time of ordering. The VP Shielding ventilation panels are manufactured to customer specification and a detailed drawing should be supplied.

Applications:

High performance steel, brass & stainless steel vents are designed for demanding applications such as screened rooms, military applications and shelters where high attenuation is required across the frequency range and particularly in the H-field. This range of ventilation panels are especially suitable for EMP and TEMPEST applications.

Specifications:

Standard Cell Sizes (Opening x Depth)

3.2 x 6.4mm	3.2 x 25.4mm	4.8 x 19.2mm
3.2 x 12.7mm	4.8 x 6.4mm	4.8 x 25.4mm
3.2 x 16mm	4.8 x 12.7mm	6.4 x 12.7mm
3.2 x 19.2mm	4.8 x 16mm	6.4 x 25.4mm

Performance: Typical Attenuation dB

FREQUENCY	FIELD	BRASS	BRASS	BRASS	STEEL	STEEL	STEEL	S/STEEL	S/STEEL	S/STEEL
		3.2mm Cell 12.7mm Thick	3.2mm Cell 25.4mm Thick	4.8mm Cell 25.4mm Thick	3.2mm Cell 12.7mm Thick	3.2mm Cell 25.4mm Thick	4.8mm Cell 25.4mm Thick	3.2mm Cell 12.7mm Thick	3.2mm Cell 25.4mm Thick	4.8mm Cell 12.7mm Thick
1 KHz	H	13	25	20	16	30	29	16	30	29
10 KHz	H	38	80	70	50	85	72	50	85	72
100 KHz	H	80	100	95	90	118	108	90	118	108
1 MHz	H	105	110	110	110	118	115	110	118	115
10 MHz	H	105	110	110	110	118	115	110	118	115
1 KHz	E	110	110	110	110	111	111	110	111	111
10 KHz	E	115	115	115	115	115	115	115	115	115
100 KHz	E	115	120	120	115	120	120	115	115	120
1 MHz	E	115	120	120	115	120	120	115	115	120
10 MHz	E	115	120	120	115	120	120	115	115	120
100 MHz	P	115	130	130	115	130	130	115	115	130
400 MHz	P	115	130	130	115	130	130	115	115	130
1 GHz	P	105	120	120	105	120	120	105	105	120
10 GHz	P	105	120	120	105	120	120	105	105	120

Note: Performance will be affected by the type of mounting used. Figures based on 300mm x 300mm test pieces.

How to order:

Produced to customer drawings.

Tolerances:

Overall dimensions $\pm 0.8\text{mm}$
Fixing holes/fasteners $\pm 0.5\text{mm}$
with jigs $\pm 0.2\text{mm}$

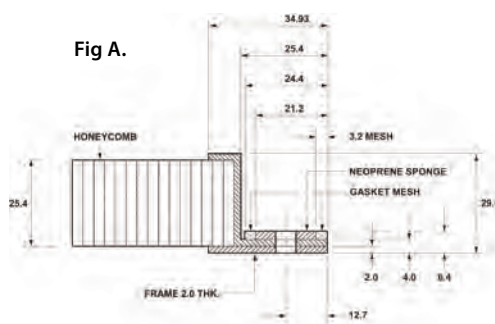
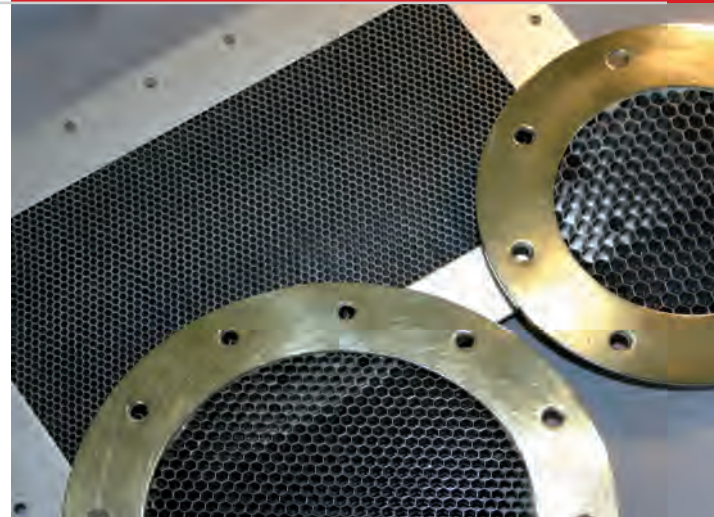
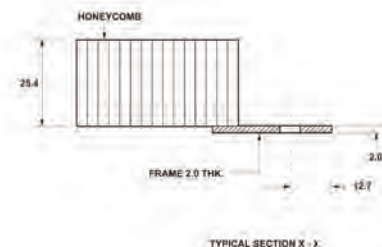

Fig B.



Nolato PPT
Unit 12 Maldon Trade park
The Causeway, Maldon
CM9 4LJ

T: +44 (0)1376 550 525
W: www.p-p-t.co.uk
E: sales.ppt@nolato.com

Our VT Shielding thin vent panels can be custom manufactured from expanded aluminium, woven aluminium or expanded Monel. When selecting the material, airflow should be considered along with the attenuation requirements.

VT thin vent panels are effectively slimmer versions of the VF air filters but with different filtration media. The VT Shielding comprises two basic types referred to as A & B.

VT(A) panels incorporate an expanded aluminium mesh which is crimped into an aluminium extrusion frame. The VT(A) style offers excellent dust filtration and RF shielding performance but considerably restricted airflow.

VT(B) vents incorporate either a woven aluminium or expanded Monel foil crimped into an aluminium extrusion.

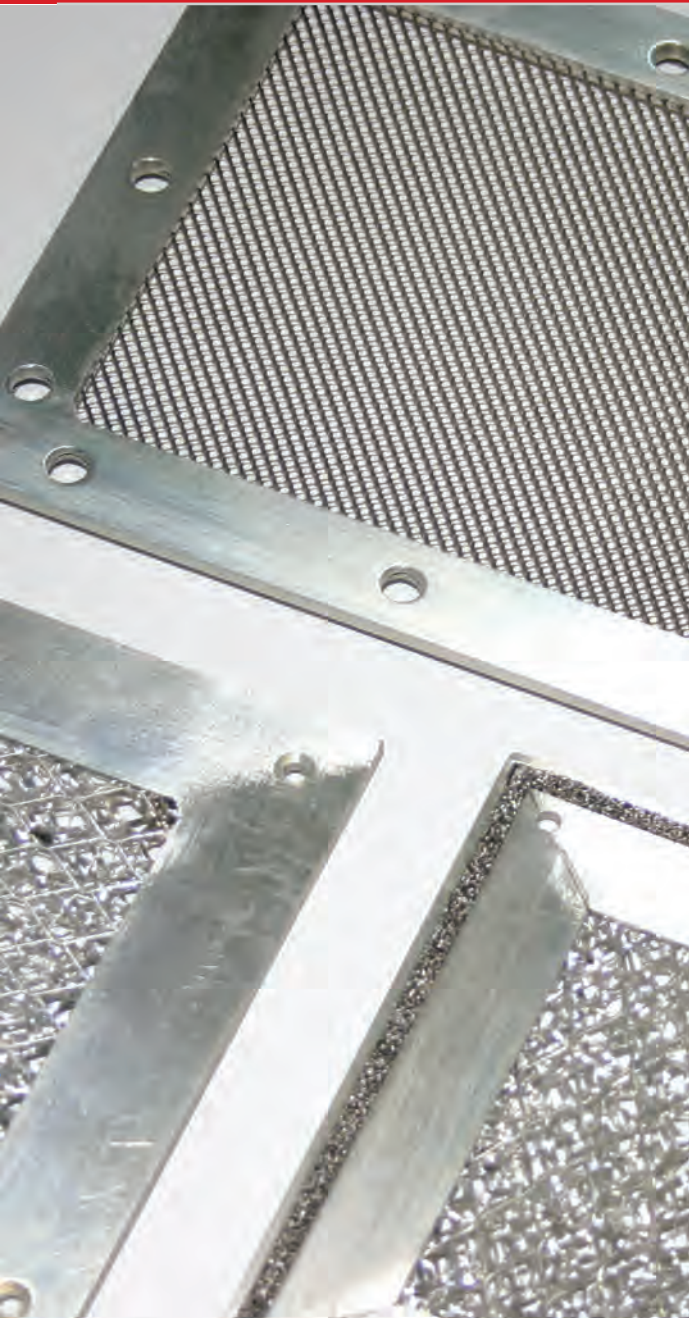

VENTSHIELD | Thin Attenuation Vent Panels VT Shielding

Applications:

Thin vent panels are designed for enclosures or racks where RF attenuation and protection from the ingress of foreign bodies is required but space is at a premium.

Expanded aluminium mesh panels are nominally 6.0mm thick inside a 4.8mm thick frame and provide attenuation levels considerably higher than the woven aluminium & expanded Monel foil types which have a very small effect on airflow but offer less shielding effectiveness.

All three shielding materials have very different properties and their airflow characteristics are a function of size, positioning, application and airflow source / volume. We suggest that a sample of the materials is requested for customer testing before specifications are finalised - please ask our sales office.

Performance: Typical Attenuation dB

FREQUENCY	FIELD	TYPE VT (A)	TYPE VT (B1)	TYPE VT (B2)
10KHz	H	25	10	10
100KHz	H	45	25	18
1MHz	H	58	35	36
1MHz	E	>100	93	>100
10MHz	E	>100	95	>100
100MHz	E	>100	97	>100
1GHz	P	73	54	45
10GHz	P	54	18	18

Note VT(B1) media is woven aluminium 0.5mm @ 16 OPI (openings per inch)
VT(B2) media is expanded Monel mesh 0.5mm @ 12 OPI

Tolerances:

Overall dimensions	±0.8mm
Fixing holes/fasteners	±0.5mm with jigs ±0.2mm

How to order:

Specify: *Series - Frame Style - Vent Media - Overall Size - Number of Fixings - Fixing Type/Size*

Where possible please provide a detailed drawing.

Example:

VT(A)-TV2-05-2320-2320-12-T/H(M4) specifies a thin vent utilising expanded and crimped aluminium alloy media within a TV2 frame with 12 size M4 through fixing holes. The gasket should be specified as shown in the gasket materials sections of the website & catalogue.

SERIES	FRAME STYLE	VENT MEDIA	OVERALL SIZE	FIXINGS (NO.)	FIXING TYPE
VT(A)	TV1 or TV2	05=Expanded Aluminium 06=Woven Aluminium	xxxx-xxxx	xx	xx
VT(B)	TV3	07=Expanded Monel			



Nolato PPT
Unit 12 & 14
Maldon Trade Park The
Causeway, Maldon
CM9 4LJ

T: +44 1376 550525 w:
www.p-p-t.co.uk E:
sale.ppt@nolato.com

SILSHIELD | Oriented Wires in Silicone

S Shielding

Applications:

Oriented wires in silicone is probably the most versatile of gasket materials. All variants provide good environmental protection and are regularly used where long service life, high performance fixed gaskets are needed. Because of the harder nature of the material, and because it needs a strong closing force through a relatively rigid cover which is screw fixed at regular intervals, they are not generally suitable for door seals or other applications where a regular opening and closing application applies. The possible exception to this is the sponge silicone variant.

They are usually supplied in gasket, strip or sheet form with a pressure sensitive adhesive backing which holds the gasket in the absence of a groove or channel. If a groove is available the gasket form is often a jointed 'o' ring without the adhesive backing.

Because oriented wire elastomers are wider than they are high, when specifying the thickness should be stated first as this will be the length of the embedded wires. Then, if the height needs to be greater than the width (i.e. to fit into a groove), there will be no doubt about your actual needs.

Particular care needs to be taken over the design of gaskets to ensure that fixing covers or doors do not distort during compression. It is often necessary to incorporate 'limit stops' into the gaskets to prevent over-compression. The material should be compressed by approximately 15% of its relaxed height. Please contact us for technical advice.

Specifications:

Solid Silicone rubber	ZZ-R-765 2b 40	
Sponge Silicone rubber	AMS 3195	
Fluorosilicone rubber	Mil-R-25988 Gr 50	
Monel wire	BS3075 – NA13	(0.11mm diameter)
Aluminium 5056	AMS 4182	(0.13mm diameter)
Phosphor Bronze Cu Sn 6%		(0.114mm diameter)

Temperature Range -65°C to +200°C

Performance: Typical dB

FREQUENCY	FIELD	ATTENUATION
10 KHz	H	55
100 KHz	H	83
1 MHz	H	>100
1 MHz	E	>120
10 MHz	E	>120
100 MHz	E	>120
400 MHz	E	>100
1 GHz	P	95
10 GHz	P	85

Tolerances:

- Thickness up to 1.0mm +0.25mm -0.15mm
- Thickness over \pm 0.25mm
- Width tolerance on sheet material \pm 1.0mm

Our range of oriented wire in silicone rubbers combines excellent environmental protection with a high level of shielding effectiveness. These products incorporate a matrix of vertically oriented wires which pierce both flat faces of the elastomer and provide around 100 contact points per square centimetre. The materials, which include solid silicone (SP Shielding) and sponge silicone (SS Shielding) variants as well as fluorosilicone (SF Shielding), sponge silicone flame retardant (SG Shielding) and solid silicone flame retardant (SR Shielding) options, are produced in sheet or strip form and are usually factory fabricated and die-cut into gasket profiles to customers specifications.



SERIES

SP=Solid Silicone

SS=Sponge Silicone

SR=Flame Retardant Solid Silicone

SG=Flame Retardant Sponge Silicone

SF= Solid Fluorosilicone

SE=Wire Free Edge / Duo



Nolato PPT
Unit 12 Maldon Trade park
The Causeway, Maldon
CM9 4LJ

T: +44 (0)1376 550 525
W: www.p-p-t.co.uk
E: sales.ppt@nolato.com

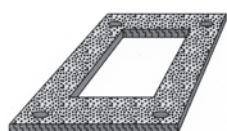

CUT GASKET FORMS

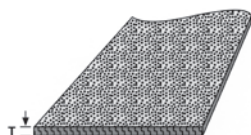

SHEET

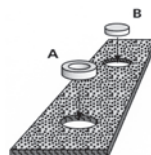

LIMIT STOPS

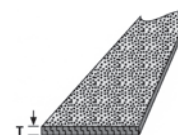

STRIP

THICKNESS mm	WIDTH mm	PART NUMBER SUFFIX
0.8	76	-0008-0760
0.8	114	-0008-1140
0.8	152	-0008-1520
0.8	228	-0008-2280
1.1	76	-0011-0760
1.1	114	-0011-1140
1.1	152	-0011-1520
1.1	228	-0011-2280
1.3	76	-0013-0760
1.3	114	-0013-1140
1.3	152	-0013-1520
1.3	228	-0013-2280
1.6	76	-0016-0760
1.6	114	-0016-1140
1.6	152	-0016-1520
1.6	228	-0016-2280
2.4	76	-0024-0760
2.4	114	-0024-1140
2.4	152	-0024-1520
2.4	228	-0024-2280
3.2	76	-0032-0760
3.2	114	-0032-1140
3.2	152	-0032-1520
3.2	228	-0032-2280
4.8	76	-0048-0760
4.8	114	-0048-1140
4.8	152	-0048-1520
4.8	228	-0048-2280
6.4	76	-0064-0760
6.4	114	-0064-1140
6.4	152	-0064-1520
6.4	228	-0064-2280
8.0	76	-0080-0760
8.0	114	-0080-1140
8.0	152	-0080-1520
8.0	228	-0080-2280
9.5	76	-0095-0760
9.5	114	-0095-1140
9.5	152	-0095-1520
9.5	228	-0095-2280

THICKNESS mm	WIDTH mm	PART NUMBER SUFFIX
1.6	3.2	-0016-0032
1.6	4.8	-0016-0048
1.6	6.4	-0016-0064
1.6	9.5	-0016-0095
1.6	12.7	-0016-0127
1.6	15.9	-0016-0159
2.4	3.2	-0024-0032
2.4	4.8	-0024-0048
2.4	6.4	-0024-0064
2.4	9.5	-0024-0095
2.4	12.7	-0024-0127
2.4	15.9	-0024-0159
3.2	3.2	-0032-0032
3.2	4.8	-0032-0048
3.2	6.4	-0032-0064
3.2	9.5	-0032-0095
3.2	12.7	-0032-0127
3.2	15.9	-0032-0159
4.8	4.8	-0048-0048
4.8	6.4	-0048-0064
4.8	9.5	-0048-0095
4.8	12.7	-0048-0127
4.8	15.9	-0048-0159
6.4	6.6	-0064-0064
6.4	9.5	-0064-0095
6.4	12.7	-0064-0127
6.4	15.9	-0064-0159
6.4	19.1	-0064-0191
6.4	25.4	-0064-0254
8.0	8.0	-0080-0080
8.0	9.5	-0080-0095
8.0	12.7	-0080-0127
8.0	15.9	-0080-0159
8.0	19.1	-0080-0191
8.0	25.4	-0080-0254
12.7	12.7	-0127-0127
12.7	15.9	-0127-0159
12.7	19.1	-0127-0191
12.7	25.4	-0127-0254
15.9	15.9	-0159-0159

Other sizes can be supplied, please contact us for further information

Please note:

- Strip material is available 900mm nominal lengths and can be factory bonded into longer sections.
- Sheet material is generally 152mm or 228mm nominal widths and can be edge bonded to greater widths.

How to order:

Standard sizes can be specified from the table above.

Alternatively, specify:

Series - Wire Type - Thickness - Width - Finish.

Examples:

SP-M-0016-0127-S/A is Solid Silicone with Monel wire 1.6 mm thick x 12.7 mm wide with self-adhesive.

SS-A-0032-1520-N/A is Sponge Silicone with Aluminium wire 3.2 mm thick x 152 mm wide no adhesive.

For strip material not shown, or specific shapes, made up gaskets and for fixing hole positions, please send a drawing and we will allocate a part number with our quotation.

WIRE TYPE	THICKNESS/WIDTH	FINISH
M=Monel	xxxx-xxxx	S/A= Self-adhesive
A=Aluminium		N/A=No adhesive
P=Phosphor Bronze		

Note: Standard material length is 900mm



Nolato PPT
Unit 12 & 14
Maldon Trade Park The
Causeway, Maldon
CM9 4LJ

T: +44 1376 550525 w:
www.p-p-t.co.uk E:
sale.ppt@nolato.com

SILSHIELD | Oriented Wires in Silicone

SE Shielding

SE Shielding:

Wire-free widths can be ordered where the material cross-section has wires along just one edge or along both edges with no wires in the centre. This provides a pressure seal and EMI shield in one component but reduces the compressive force needed to fit the gasket.



Dual material variants can also provide the advantages of a fluorosilicone gasket with the cost-effectiveness of plain silicone by bonding a wire-free fluoro-edge to a standard sheet or strip during the moulding process. Fabricated gaskets have a wire-free, contaminant resistant outer edge suitable for applications where loose wires could cause problems when gaskets are subjected to solvents or hydrocarbons and are liable to soften and swell.

Please contact the sales office for further details and to discuss your requirements.

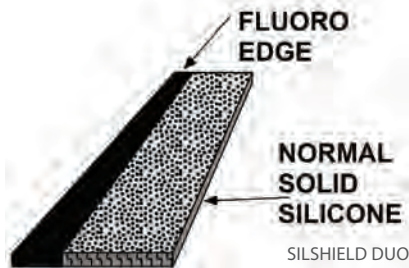

How to order:

SERIES	WIRE TYPE		FINISH
SP=Solid Silicone	M=Monel	xxxx-xxxx	S/A= Self-adhesive
SS=Sponge Silicone	A=Aluminium		N/A=No adhesive
SR=Flame Retardant Solid Silicone	P=Phosphor Bronze		
SG=Flame Retardant Sponge Silicone			
SF= Solid Fluorosilicone			
SE=Wire Free Edge / Duo			

Note: Standard material length is 900mm

Standard sizes can be specified from the table on page 21. Alternatively, specify: *Series - Wire Type - Thickness - Width - Finish*

Examples:

SP-M-0016-0127-S/A is Solid Silicone with Monel wire 1.6 mm thick x 12.7 mm wide with self-adhesive.

SS-A-0032-1520-N/A is Sponge Silicone with Aluminium wire 3.2 mm thick x 152 mm wide no adhesive.

For strip material not shown, or specific shapes, made up gaskets and for fixing hole positions, please send a drawing and we will allocate a part number with our quotation.



Nolato PPT
Unit 12 Maldon Trade park
The Causeway, Maldon
CM9 4LJ

T: +44 (0)1376 550 525
W: www.p-p-t.co.uk
E: sales.ppt@nolato.com

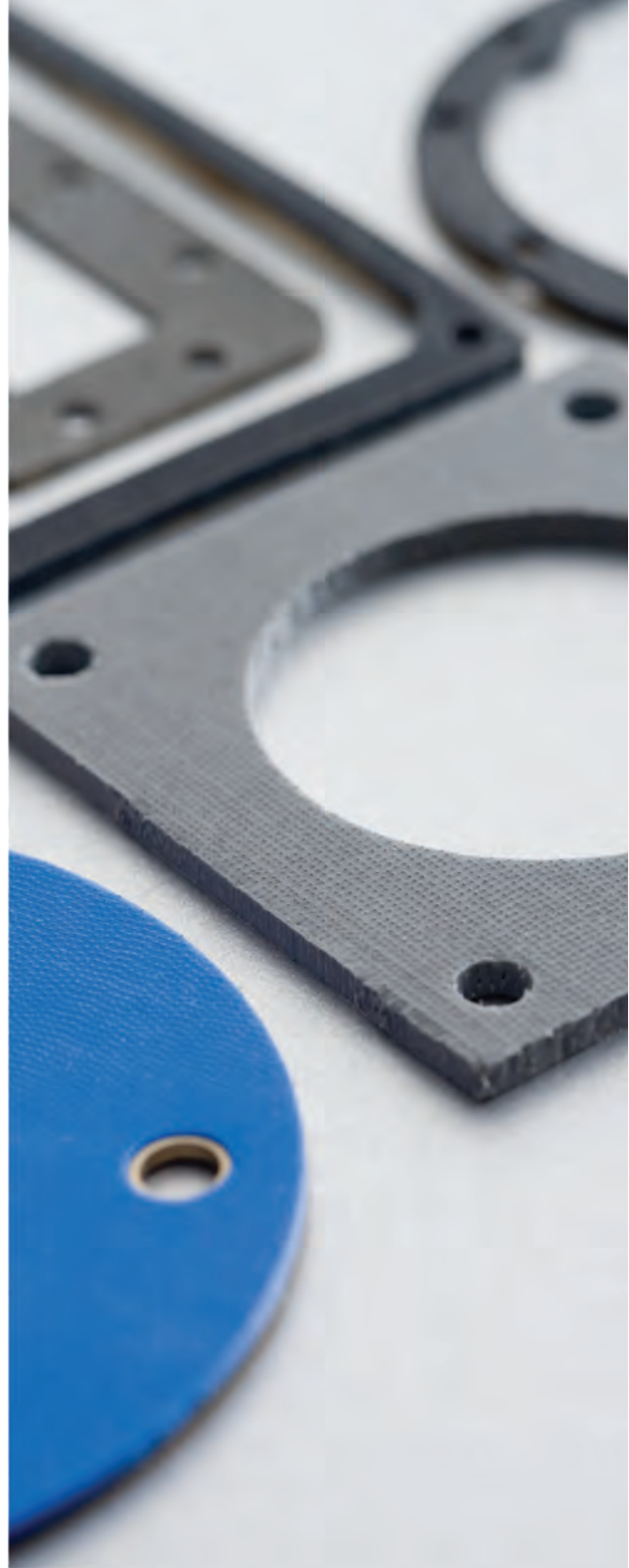

WINSHIELD | Shielded Windows W Shielding

Fully laminated (WF Shielding) screened windows combine the physical strength and optical clarity of laminated glass or plastic with the shielding effectiveness of fine wire mesh. They complement the more cost-effective edge-laminated type (WG Shielding), which are designed primarily for racks and large enclosures. Cast plastic style (WC Shielding), featuring mesh moulded into clear plastic, complete the W Range.

Copper wire meshes, which form a highly conductive shielding medium, are available with a conductive anti-reflective 'blackened' finish which is non-oxidising and which protects the mesh, particularly where copper is used for its high degree of shielding effectiveness. In some instances we can supply the mesh material in its unlaminated form so customers can fabricate their own bespoke windows (WM Shielding). However, we do not recommend this to customers inexperienced in handling the fine mesh, which is easily contaminated or damaged.

Windows with mesh typically have in excess of a 60% open area so provide good light transmission. Attenuation is a function of conductivity, aperture sizes and permeability in relation to field strength and frequency. Conventional mesh materials or surface coatings in windows do not generally provide high attenuation at low frequency in the magnetic field and additional measures should be taken to supplement the screened window performance in such applications. Electric field and plane wave attenuation is, however, normally excellent and this is the area of activity for most non-military window applications. Please contact us for technical advice.

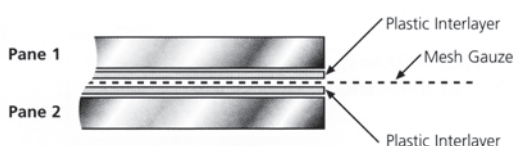

BASIC CONSTRUCTION: FULL LAMINATION - With Plastic Interlayers

Applications:

Our EMI screened windows use glass and polycarbonate as their base substrate, and can be treated to improve both anti-reflective and scratch-resistant properties. Glass panels can be etched to provide an anti-reflective surface. Tinted 'interlayers' can be built into fully laminated windows to improve their anti-reflective properties particularly where, for example, non-treated stainless steel mesh is used.

When specifying the design for a particular application, temperature cycling, contamination and possible accidental damage should be taken into account. Glass windows are the most abrasion resistant but not the best for impact resistance. They are also better for anti-contamination than plastic. Fully laminated windows have good properties but are less cost effective than edge-laminated types, which provide an excellent solution for most applications.

Screened windows are generally mounted within a frame or clamp system or are bonded onto a fascia or door panel using conductive adhesive or caulking. Stepped windows (fully laminated only) may have a front pane protruding through a fascia, with the rear pane bonded inside the enclosure. The way in which the screen material inside the window is terminated depends on the type of window – see the individual series sections for further details. Gaskets are another important feature that is taken into consideration as shielded windows are often used where environmental protection is essential.

Bezel mounts can be made to suit most windows. The mounts are fabricated from aluminium, steel or other suitable metals and can be hinged or fitted with quick-action fasteners if required.

Fully Laminated Windows | WF Shielding:

Fully laminated windows in glass or plastic can be produced either as individual windows or, for smaller size, in sheet form and machined into segments. All fully laminated windows are available with or without a step and with or without a silver painted busbar. Surface treatments for scratch resistance or anti-reflectance are available and tinted inter-layers for anti-reflectance or contrast enhancement can be supplied on request.

Standard terminations for individually produced windows are flying mesh, foil or silver painted busbar or conductive gasket. Sheet-cut windows, including stepped types, are only available with silver busbar and optional gaskets. Care should be taken with stepped windows, particularly glass ones, as the pressure exerted by the gasket under compression can easily overstress even a fully laminated window. We suggested that stepped windows should be plastic or a composite where the glass pane is not under pressure when mounted.

Most gaskets in our range can be used with shielded windows and the actual type selected will depend on the degree of shielding and environmental protection required. Please contact us for technical advice.



Nolato PPT
Unit 12 & 14
Maldon Trade Park The
Causeway, Maldon
CM9 4LJ

T: +44 1376 550525 w:
www.p-p-t.co.uk E:
sale.ppt@nolato.com

WINSHIELD | Shielded Windows W Shielding



Edge Bonded Windows | WG Shielding:

Edge bonded windows use the same substrates and mesh as the fully laminated windows but are laminated around their edges, outside the 'viewing area', only and are lower cost. They are not as suitable for stepped construction but if the windows are relatively small or when the viewing area remains smaller than the smallest of the two pieces (i.e. bezel mounted where the edge remains covered albeit stepped) it is not a major problem. Standard edge bonded windows are a cost-effective solution for most commercial applications.

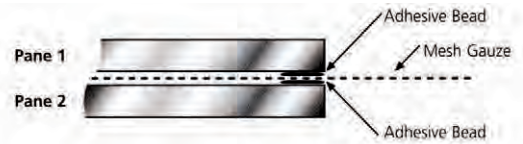

BASIC CONSTRUCTION: EDGE BONDED - Square Edge



BASIC CONSTRUCTION: EDGE BONDED - Stepped Edge



BASIC CONSTRUCTION: CAST WINDOWS - Integral Mesh

Cast Plastic Windows | WC Shielding:

Cast windows are formed by encapsulating the mesh within a thermosetting plastic or resin substrate. The process has advantages inherent to the manufacturing technique, such as surface finishes, tints, minimum thickness and physical strength. The process necessitates a silver busbar termination although a stepped construction is possible during the machining of the cast blank. Cast windows cost more than edge laminated ones but are more robust for specialist applications.

Gasket Options:

1. Flying mesh windows generally bond both the window and the flying mesh to a convenient point on the equipment. However, the window and/or the mesh can be fitted with most gasket types. The mesh can be wrapped around a sponge material and clipped into position.
2. Silver busbar windows can be supplied with gaskets made from oriented wires in silicone, knitted mesh or conductively loaded silicone.
3. Extended mesh options (with or without foil busbar) are readily fitted with various forms of gaskets such as knitted mesh, conductive fabric or oriented wires in silicone.

Please contact us to discuss your gasket or frame requirements.

TERMINATION METHODS

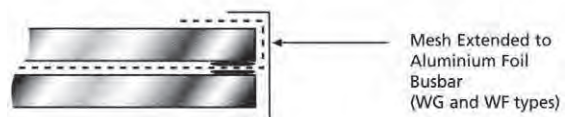
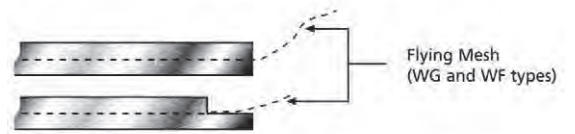

Nolato PPT
Unit 12 Maldon Trade park
The Causeway, Maldon
CM9 4LJ

T: +44 (0)1376 550 525
W: www.p-p-t.co.uk
E: sales.ppt@nolato.com

WINSHIELD | Shielded Windows W Shielding

Specifications and material types available

Glazing media:

Glass, including clear, diffused and toughened.

Polycarbonate, including clear, hard-faced, anti-reflective, tinted, polarised and filtered.

Polycarbonate can also be conductively coated with ITO (Indium Tin Oxide) but this is a restricted option as a minor scratch on ITO can dramatically reduce its shielding effectiveness.

Mesh Media:

Woven copper (which can be anti-reflective treated) or stainless steel mesh. Typically 100 OPI.

Other wire types including knitted meshes, finishes and OPI configurations are available to order - minimum quantities apply, please contact us for more information.

Tolerances:

Glass thickness	± 0.5 mm
Overall dimensions	± 1.0 mm to 300mm, ± 1.5 mm to 600 mm
Plastics thickness	± 0.5 mm per piece
Overall dimensions	± 0.5 mm to 300 mm, ± 1.0 mm to 600 mm

Performance:

Shielding effectiveness in dB, typical values tested in accordance with MIL-STD-285 with test samples of woven copper mesh 300 x 300 mm

It is important to note that a smaller test sample would return a far higher attenuation and all manufacturers data should be compared on this basis to avoid misinterpretation.

FREQUENCY	FIELD	100 OPI	50 OPI
10 KHz	H	20	15
100 KHz	H	40	35
1 MHz	H	50	45
1 MHz	E	>100	>100
10 MHz	E	>100	>100
100 MHz	E	80	75
1 GHz	P	60	55
10 GHz	P	30	20

How to order:

Generally by description and customers drawings indicating dimensions, finishes, fixings, gasket type and method plus the generic window group e.g. WC Shielding. Please contact us to discuss your individual requirements.

Window Meshes | WM Shielding:

We also supply Woven Copper and Stainless Steel meshes for customers to make their own screens. Untreated (non-blackened) mesh material is available pre-cut although it is advisable to order this by the linear metre to avoid handling and fraying problems. Blackened copper mesh can be pre-cut and packed in bulk or single sheets for ease of handling.

Material types available:

Copper and Stainless Steel.

Material width:

Normally 1200 mm which we will confirm at time of order.

Openings per inch (OPI):

Standard = 100
Special = 50, 70 and 145 (minimum quantities apply)

Wire diameters:

.002" and .001" (.051 and .025 mm)

How to order:

Generally by description, stating wire type, finish, size and tolerances if cut pieces.



Nolato

Nolato PPT
Unit 12 & 14
Maldon Trade Park The
Causeway, Maldon
CM9 4LJ

T: +44 1376 550525 w:
www.p-p-t.co.uk E:
sale.ppt@nolato.com

METWEAVE | Woven Fabric Gaskets

MW Shielding

MW Shielding fabric wrapped screening profiles utilise a highly conductive and durable impregnated fabric formed around a sponge or foam core to create a very versatile low compression gasket.

Applications:

Conductive or 'Metweave' fabric covered profiles are particularly suitable for fixed-gasket applications within the computer or telecommunications manufacturing sectors as they are easily trimmed to size, are self-terminating and provide excellent dust and moisture protection coupled with a high degree of EMI shielding.

Conductive Metweave fabric is available in strip form or as ready to fit pre-formed or jointed gaskets. The standard materials have a self-adhesive backing and can be quickly and easily fixed in position. Corner joints can be mitred or butt-jointed according to cross-section without the need to bond or seal the cut ends against fraying. All metweave fabric is rip-stop unless otherwise specified.

Specifications:

Open and closed-cell foam and sponge rubber cores are available (polyurethane & EPDM). The fabric can also be applied around rubber tube profiles.

Surface resistivity:	Nickel/Copper < 0.05 Ω^2
Abrasion resistance:	Excellent
Compression set:	< 10% (typical)
Temperature range:	-40°C to +70°C (typical)

Performance: Typical dB

FREQUENCY	ATTENUATION
30 MHz	90
100 MHz	>100
500 MHz	>100
1 GHz	>100
10 GHz	110

Tolerances:

Up to 16mm	±0.8mm
Up to 48mm	±1.5mm
Up to 100mm	±2.0mm

How to order:

Specify: *Series - Fabric - Filler (core) - Shape - Size - Length - Finish*
For finished gaskets please provide a detailed drawing.

Examples:

MW-CN-PU-11-0500-0500-S/A is Metweave with polyurethane foam core, 5 x 5 mm D-Section with self-adhesive.

MW-CN-EP-70-0100-0030-N/A is Metweave with EPDM Sponge core, 10 x 3 mm rectangular section without adhesive.

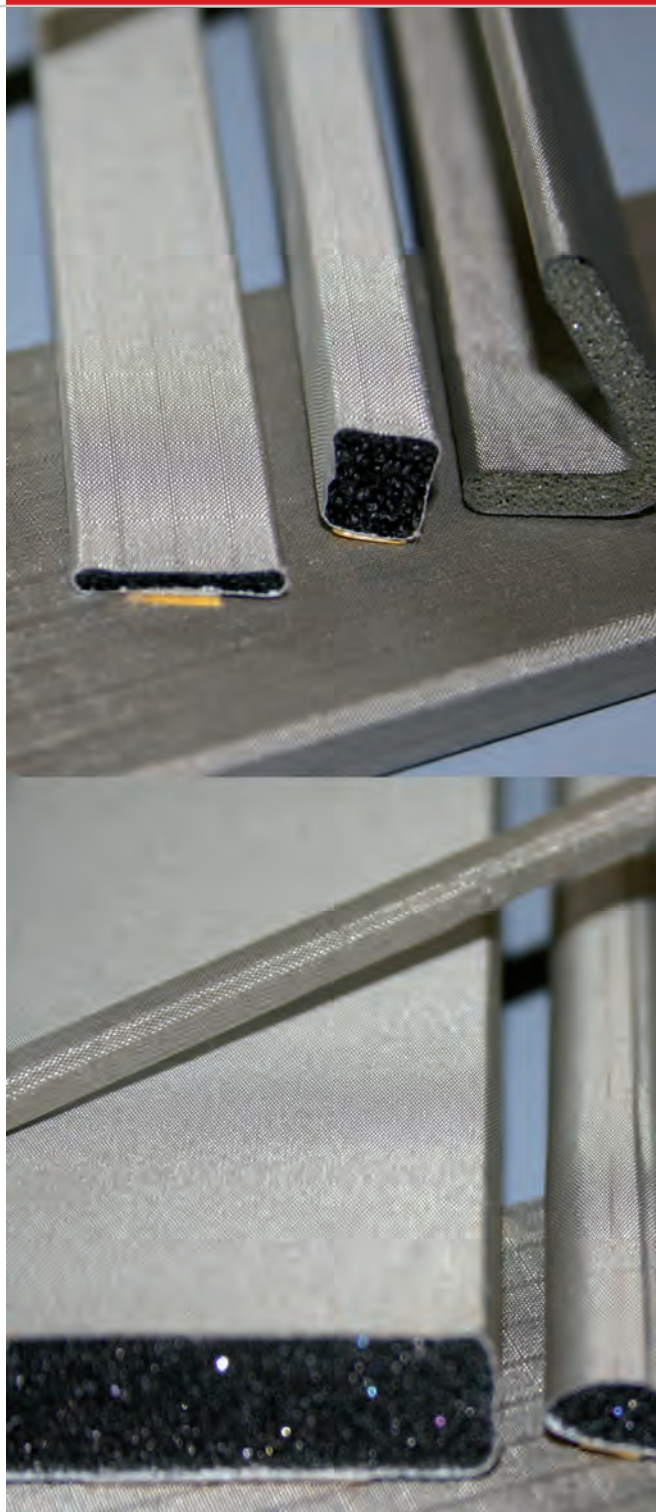

SERIES	FABRIC	FILLER (CORE)	SHAPE	SIZE	FINISH
MW=Metweave	Copper/Nickel	PU=Polyurethane EP=EPDM Sponge	70=Rectangular 11=D-Section 88=C Section 60=Round 80=P-Section 90=Double D 77=Knife-edge 66=L-Section	xxxx-xxxx	N/A= No Adhesive S/A= Self-Adhesive



Nolato PPT
Unit 12 Maldon Trade park
The Causeway, Maldon
CM9 4LJ

T: +44 (0)1376 550 525
W: www.p-p-t.co.uk
E: sales.ppt@nolato.com

METWEAVE | Woven Fabric Gaskets

MW Shielding

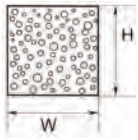

RETANGULAR

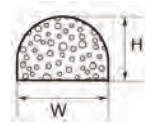

D-SHAPE

WIDTH mm	HEIGHT mm	PART NUMBER
2	2	MW-CN-PU-70-0020-0020
3	3	MW-CN-PU-70-0030-0030
4	4	MW-CN-PU-70-0040-0040
5	5	MW-CN-PU-70-0050-0050
6	6	MW-CN-PU-70-0060-0060
8	8	MW-CN-PU-70-0080-0080
10	10	MW-CN-PU-70-0100-0100
12	12	MW-CN-PU-70-0120-0120
13	13	MW-CN-PU-70-0130-0130
15	15	MW-CN-PU-70-0150-0150

WIDTH mm	HEIGHT mm	PART NUMBER
3.9	1.5	MW-CN-PU-11-0039-0015
6.4	2.3	MW-CN-PU-11-0064-0023
9	3	MW-CN-PU-11-0090-0030
15	5	MW-CN-PU-11-0150-0050
4.3	2.7	MW-CN-PU-11-0043-0027
4	3.8	MW-CN-PU-11-0040-0038
6.4	3.6	MW-CN-PU-11-0064-0036
10	6	MW-CN-PU-11-0100-0060
10	10	MW-CN-PU-11-0100-0100
12	10	MW-CN-PU-11-0120-0100



C-FOLD

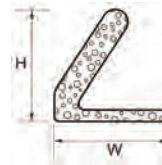

L-SHAPE

WIDTH mm	HEIGHT mm	PART NUMBER
7.1	6.4	MW-CN-PU-88-0071-0064
8	8	MW-CN-PU-88-0080-0080
10.7	9.8	MW-CN-PU-88-0107-0098
10.9	10	MW-CN-PU-88-0109-0100
10.9	10.2	MW-CN-PU-88-0109-0102

WIDTH mm	HEIGHT mm	PART NUMBER
12	11	MW-CN-PU-66-0120-0110
11	11	MW-CN-PU-66-0110-0110
15	13	MW-CN-PU-66-0150-0130
19	17	MW-CN-PU-66-0190-0170
14.7	17.1	MW-CN-PU-66-0147-0171



KNIFE-EDGE



P-SHAPE

WIDTH mm	HEIGHT mm	PART NUMBER
11.3	2.7	MW-CN-PU-77-0113-0027
11.4	2.8	MW-CN-PU-77-0114-0028
19.1	6.4	MW-CN-PU-77-0191-0064
18	7.9	MW-CN-PU-77-0180-0190
19.1	8.9	MW-CN-PU-77-0191-0089

WIDTH mm	HEIGHT mm	PART NUMBER
14	3	MW-CN-PU-80-0140-0030
15	3	MW-CN-PU-80-0150-0030
13	2	MW-CN-PU-80-0130-0020
17	7	MW-CN-PU-80-0170-0070
8	2	MW-CN-PU-80-0080-0020
22.5	9.5	MW-CN-PU-80-0225-0095
12.2	5.1	MW-CN-PU-80-0122-0051
13.2	3.7	MW-CN-PU-80-0132-0037

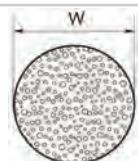

ROUND

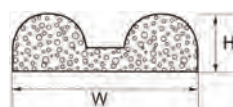

DOUBLE D-SHAPE

WIDTH mm	PART NUMBER
3	MW-CN-PU-60-0030
6	MW-CN-PU-60-0060
9	MW-CN-PU-60-0090
10	MW-CN-PU-60-0100
12	MW-CN-PU-60-0120

WIDTH MM	HEIGHT mm	PART NUMBER
9.6	3.2	MW-CN-PU-90-0096-0032
9.7	2.8	MW-CN-PU-90-0097-0028

Note:

Minimum order quantities may apply as not all profiles are stock parts - please contact us for more details.



Nolato PPT
Unit 12 & 14
Maldon Trade Park The
Causeway, Maldon
CM9 4LJ

T: +44 1376 550525 w:
www.p-p-t.co.uk E:
sale.ppt@nolato.com

METWEAVE | Conductive Fabric

MF Shielding

MF Shielding:

MF Shielding is a range of highly conductive metallised fabrics. They consist of a base material of nylon coated with nickel/copper. The fabrics have excellent conductivity in all directions and exhibit outstanding shielding effectiveness. They are very flexible and are ideal for wrapping around core material or for die stamping. The fabric has good abrasion resistance of in excess of 500,000 cycles and is fire retardant to UL94 V0.

Various adhesive options are available, including a hot melt or a pressure sensitive adhesive on one side or it can be supplied without adhesive. For advice on applications, please consult our sales office.

How to order:

Specify: *Series - Part Number - Length/Drawing Number - Finish*

SERIES	PART NUMBER	LENGTH / DWG.	FINISH
MF=Conductive Fabric	NF32B=Nylon/PET/Cu+Ni Ripstop Fabric	xxxx	S/A= Self Adhesive
	PF31B=PET/Cu+Ni Fabric Plain Weave		N/A=No Adhesive
			H/A= Heat activated Adhesive

Example:

MF-NF32B-H/A is Nylon/PET/Cu+Ni ripstop fabric with heat activated adhesive.

Note:

A wide range of additional conductive fabrics is available - please contact us for further details.

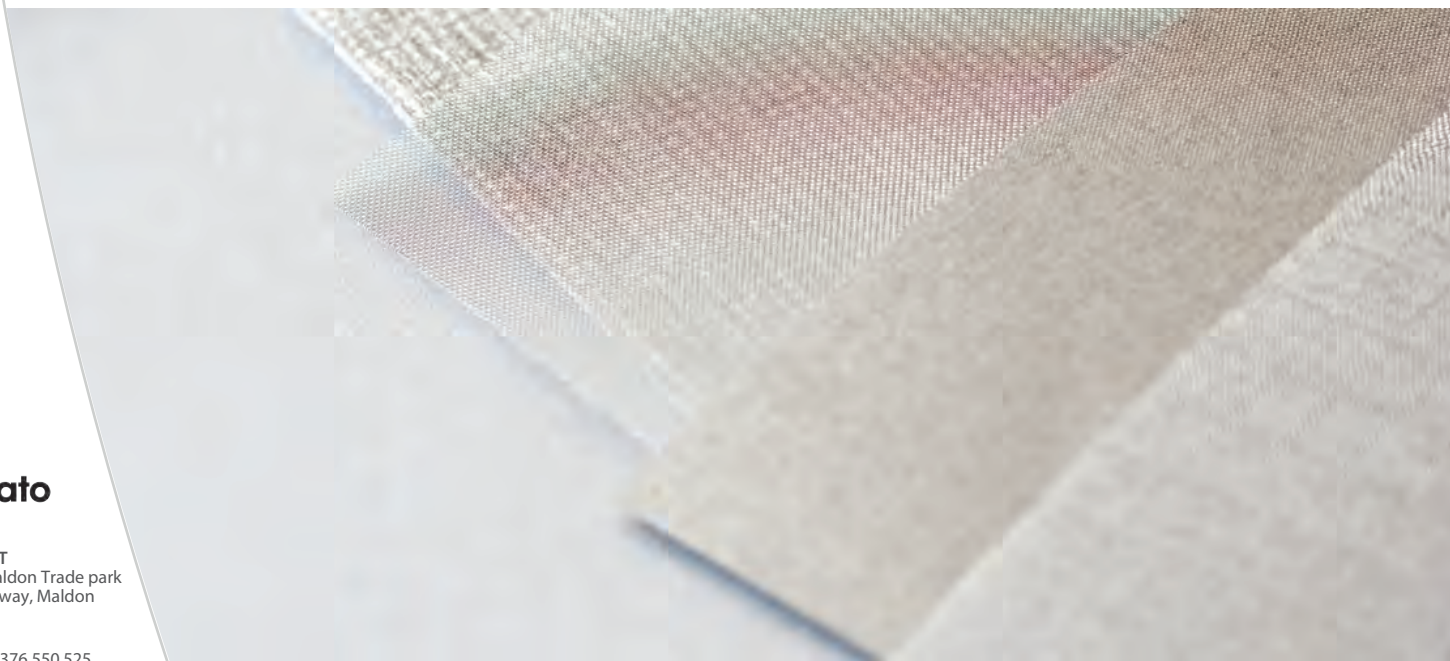

Nolato PPT
Unit 12 Maldon Trade park
The Causeway, Maldon
CM9 4LJ

T: +44 (0)1376 550 525
W: www.p-p-t.co.uk
E: sales.ppt@nolato.com

METWEAVE | Conductive Sponge MS Shielding

MS Shielding:

Our MS Shielding is a conductive polyurethane sponge with a conductive fabric bonded to each face. It is available in a range of thicknesses and can be supplied with or without a conductive adhesive on one face. The material is highly conductive in all planes (X,Y & Z axis) with a typical resistance of $\leq 1.00\Omega$. The material is easily die-cut and is ideal for connector gaskets or where a gap needs to be filled without high compression.

Performance: Typical dB

FREQUENCY	ATTENUATION
10 MHz	≥ 60
100 MHz	≥ 60
500 MHz	≥ 60
1GHz	≥ 60
3 GHz	≥ 60

How to order:

Specify: Series - Part Number/Thickness - Size/Drawing Number - Finish

SERIES	PART NUMBER	SIZE	FINISH
MS=Conductive Sponge	1013=1.3mm ± 0.3 Thick	xxxx-xxxx	S/A=Self-Adhesive
	1025=2.5mm ± 0.5 Thick		N/A=No Adhesive
	1035=3.5mm ± 0.5 Thick		

Example:

MS-1035-5000-5000-S/A is conductive sponge 3.5 mm thick 500 x 500 mm with self-adhesive.

Note:

Maximum material width is 1200mm ± 5 mm.



Nolato PPT
Unit 12 & 14
Maldon Trade Park The
Causeway, Maldon
CM9 4LJ

T: +44 1376 550525 w:
www.p-p-t.co.uk E:
sale.ppt@nolato.com

CONDUCTIVE FINGER STRIPS

CFS Shielding

Our Conductive Finger Strips are available in a wide range of profiles, a choice of two materials and six finishes. There is also a choice of a conductive self-adhesive fixing or clip on.

They have a low closing force and do not take a compression set. They have long service life with good corrosion resistance.

How to order:

Specify: Series - Style Number - Length - Finish - Plating

Examples:

CFS-0645-406mm-S/A-Bd is contact finger strip, style 0645, 406mm long, beryllium copper with self-adhesive, bright finish

CFS-0697-7.6M-S/A-Ni is contact finger strip, style 0697, 7.6 metres long, beryllium copper with self-adhesive, nickel plated

CFS-0636SS-406mm-S/A is contact finger strip, style 0636SS, 406mm long, stainless steel with self-adhesive.



SERIES	STYLE	LENGTH	FINISH	PLATING
CFS	See drawings	xxxx	S/A=Self-Adhesive N/A=No Adhesive	Bd=Bright Finish Sn=Bright Tin Ni=Bright Nickel Ag=Silver Au=Gold
* Plating is not available on stainless steel				

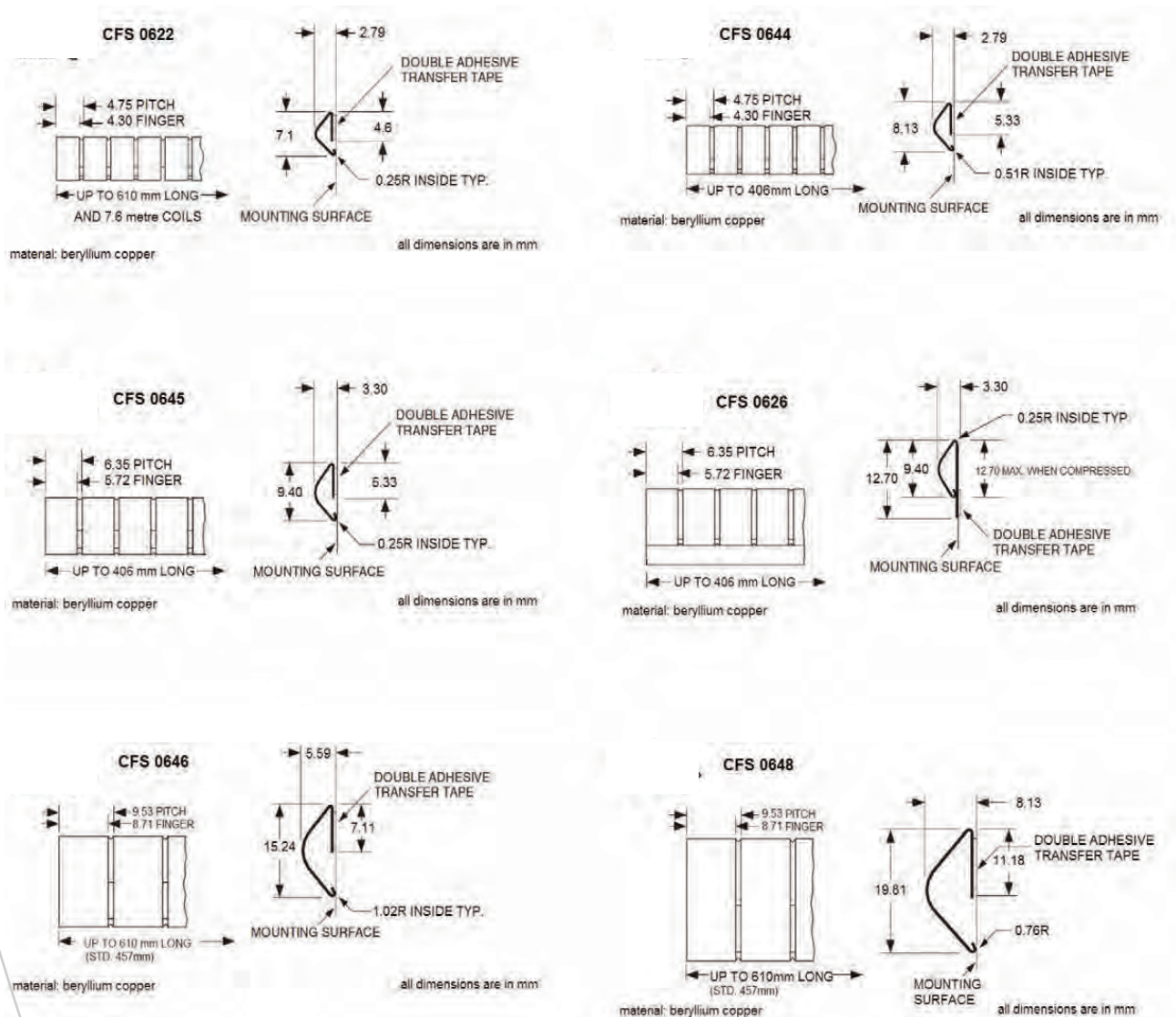

Nolato PPT
 Unit 12 Maldon Trade park
 The Causeway, Maldon
 CM9 4LJ

T: +44 (0)1376 550 525
 W: www.p-p-t.co.uk
 E: sales.ppt@nolato.com

CONDUCTIVE FINGER STRIPS

CFS Shielding

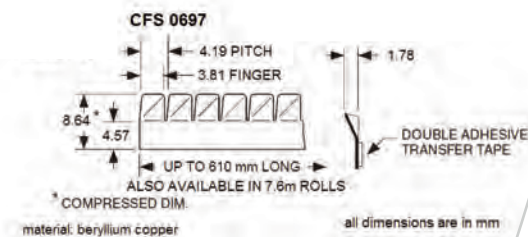
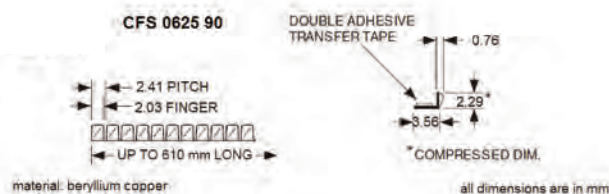
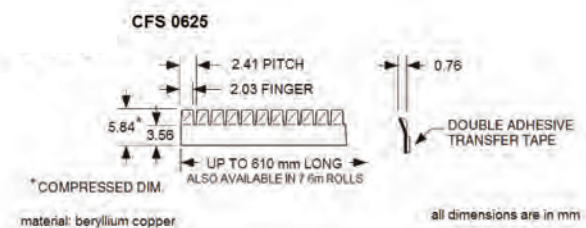
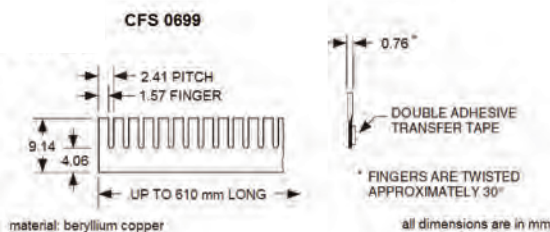
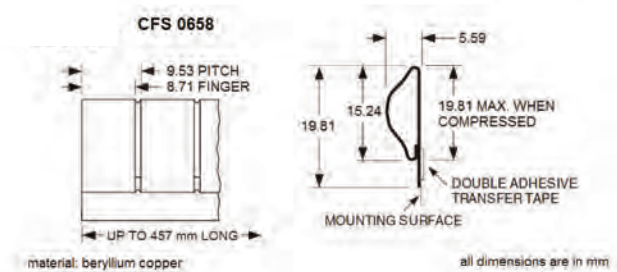
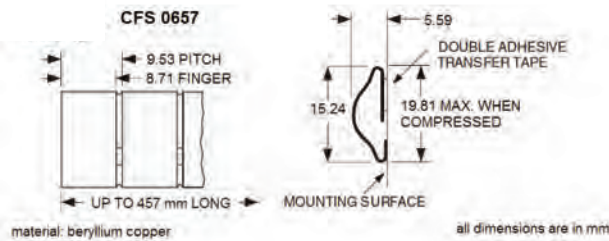
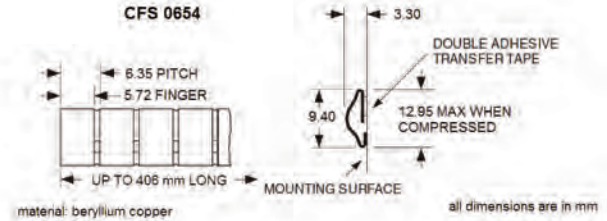
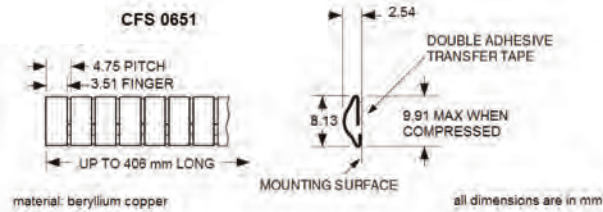
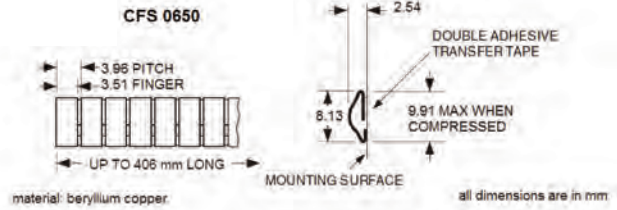
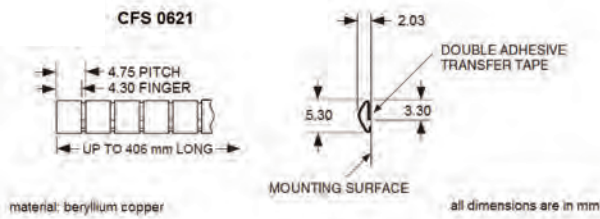
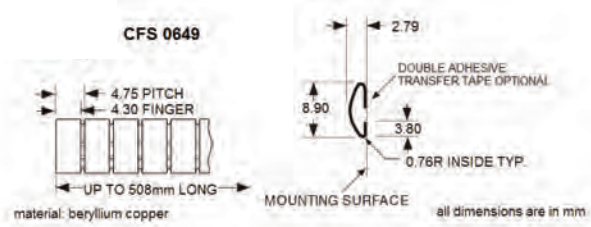
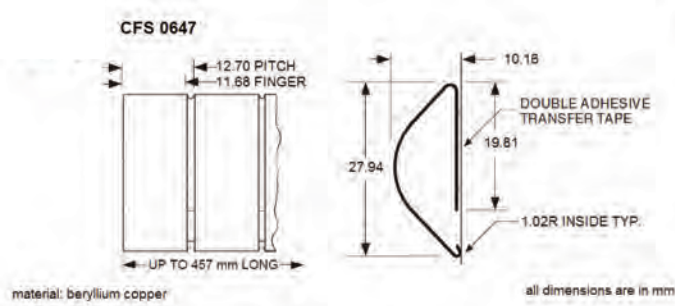

Nolato PPT
Unit 12 & 14
Maldon Trade Park The
Causeway, Maldon
CM9 4LJ

T: +44 1376 550525 w:
www.p-p-t.co.uk E:
sale.ppt@nolato.com

CONDUCTIVE FINGER STRIPS

CFS Shielding

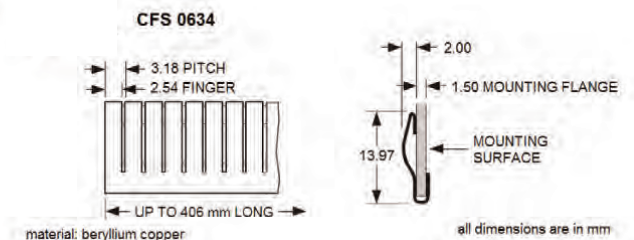
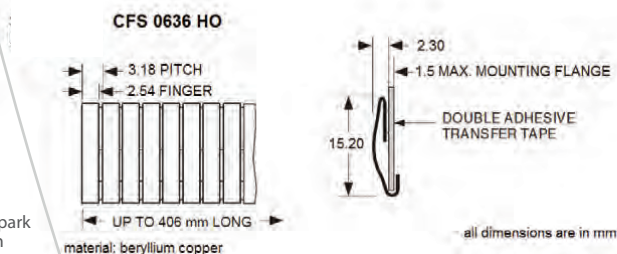
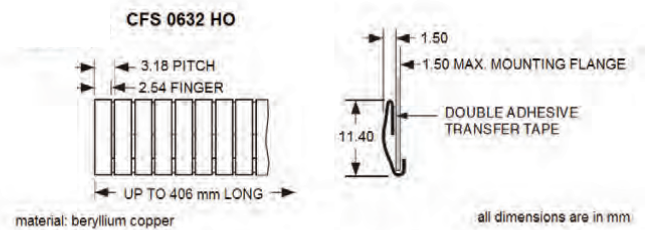
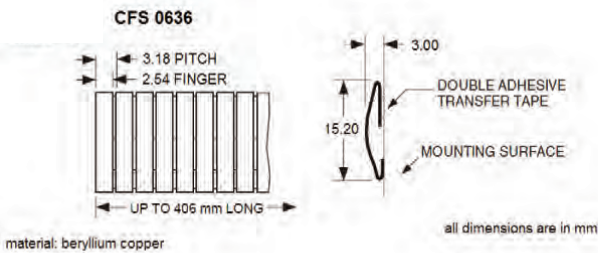
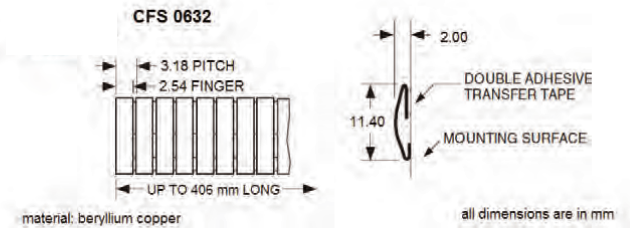
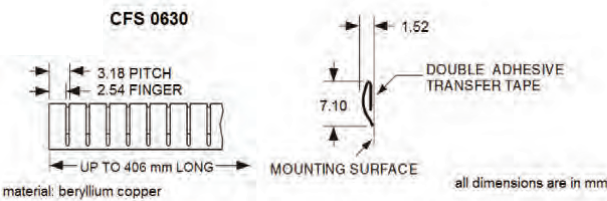
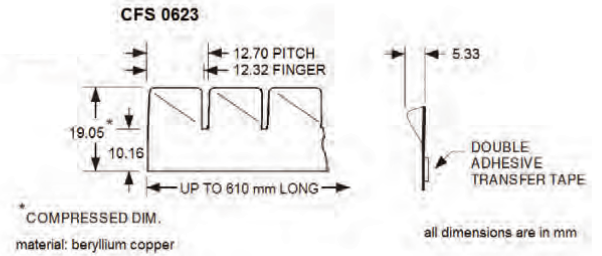
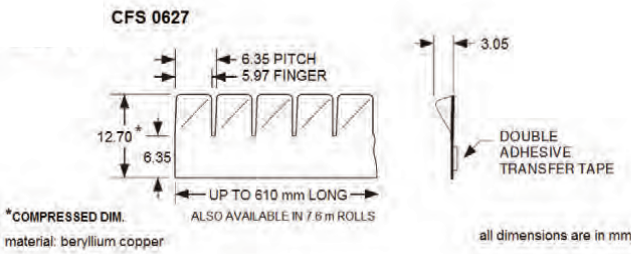
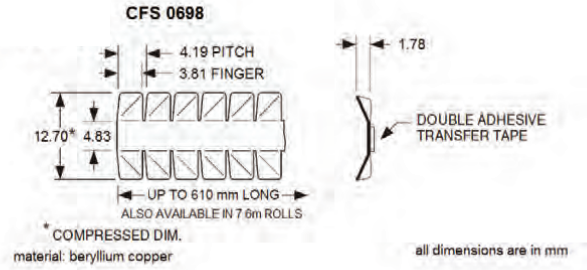
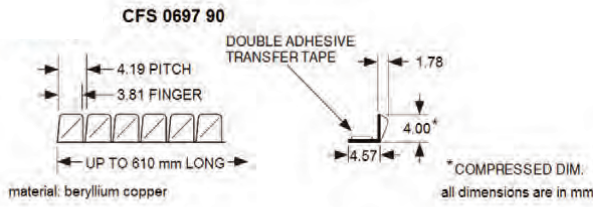

Nolato PPT
Unit 12 Maldon Trade park
The Causeway, Maldon
CM9 4LJ

T: +44 (0)1376 550 525
W: www.p-p-t.co.uk
E: sales.ppt@nolato.com

CONDUCTIVE FINGER STRIPS

CFS Shielding

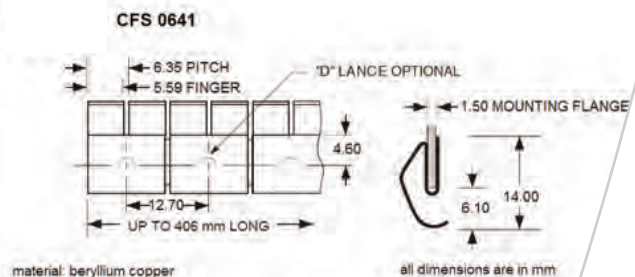
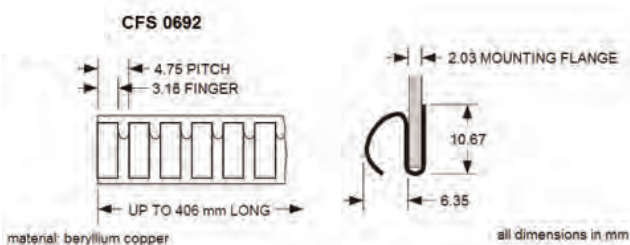
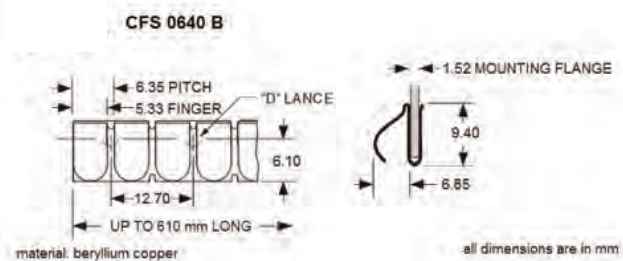
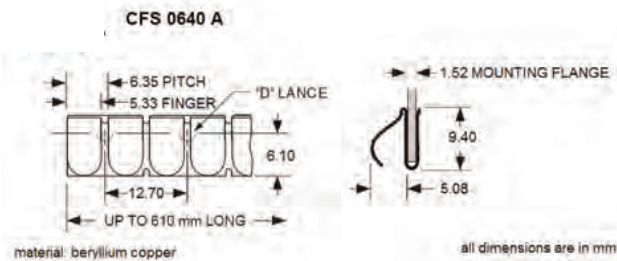
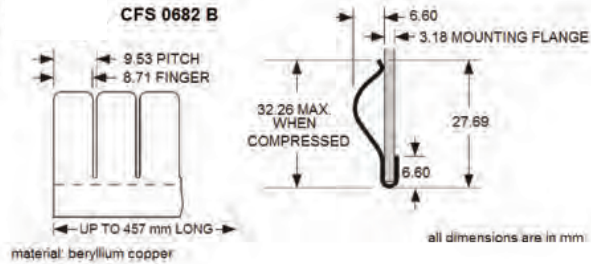
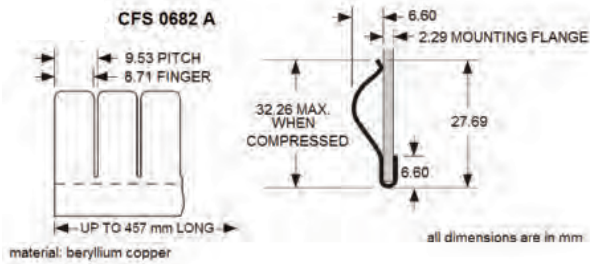
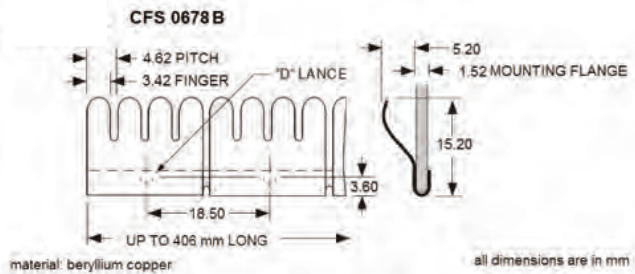
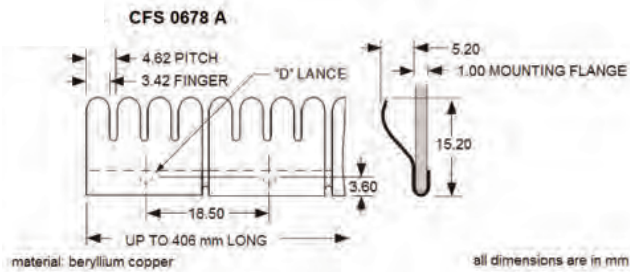
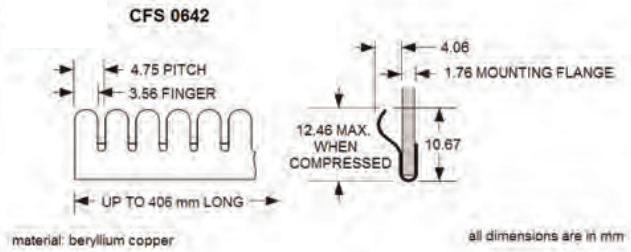
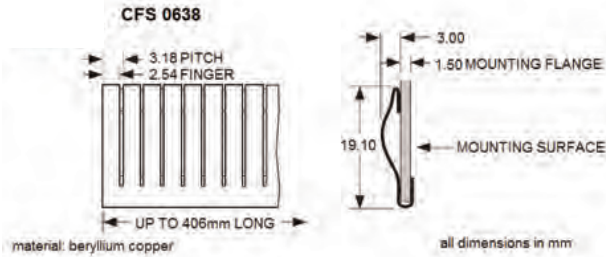

Nolato PPT
Unit 12 & 14
Maldon Trade Park The
Causeway, Maldon
CM9 4LJ

T: +44 1376 550525 w:
www.p-p-t.co.uk E:
sale.ppt@nolato.com

CONDUCTIVE FINGER STRIPS

CFS Shielding

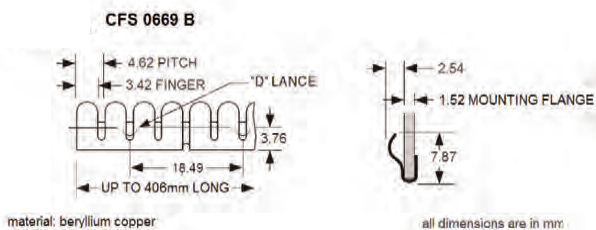
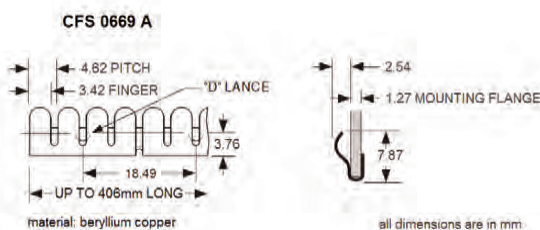
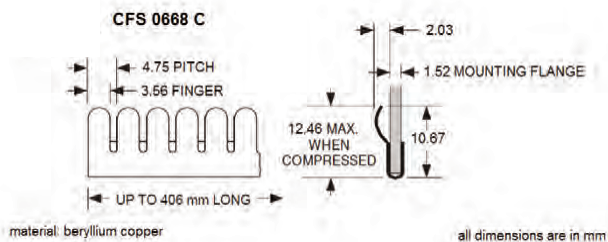
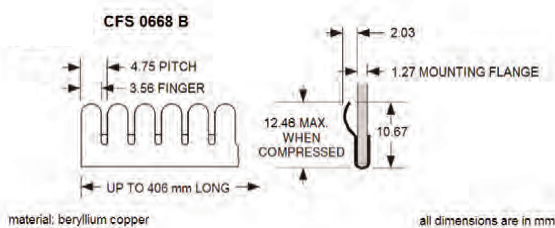
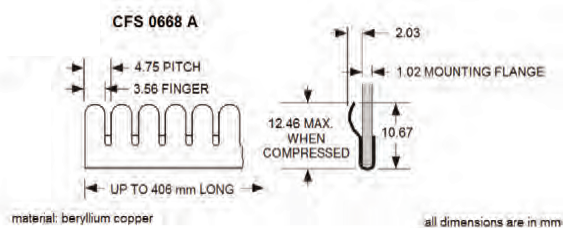
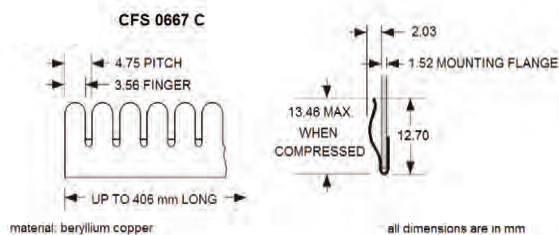
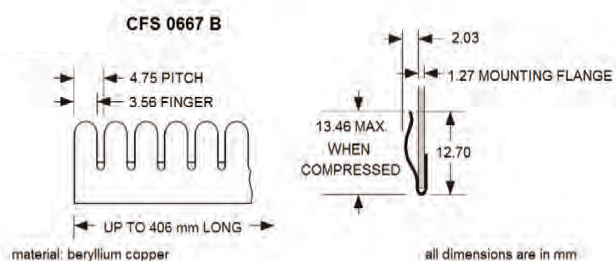
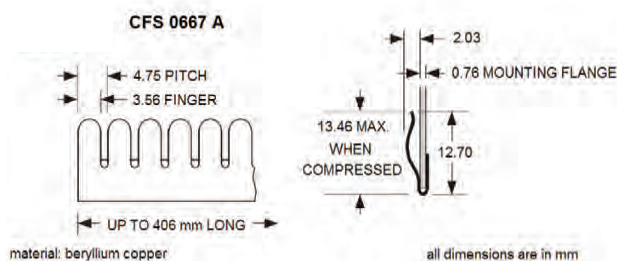
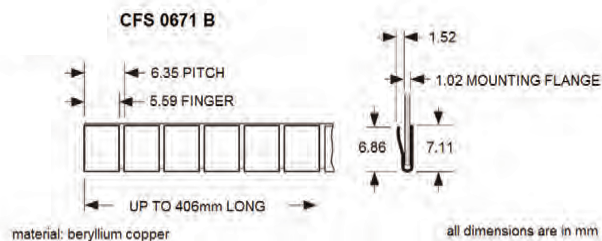
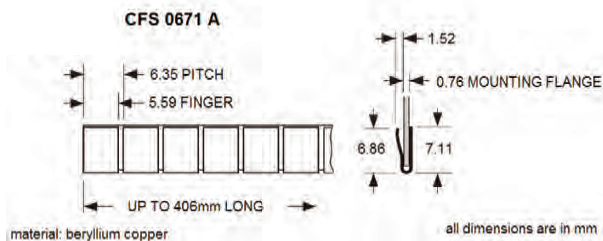

Nolato PPT
Unit 12 Maldon Trade park
The Causeway, Maldon
CM9 4LJ

T: +44 (0)1376 550 525
W: www.p-p-t.co.uk
E: sales.ppt@nolato.com

CONDUCTIVE FINGER STRIPS

CFS Shielding

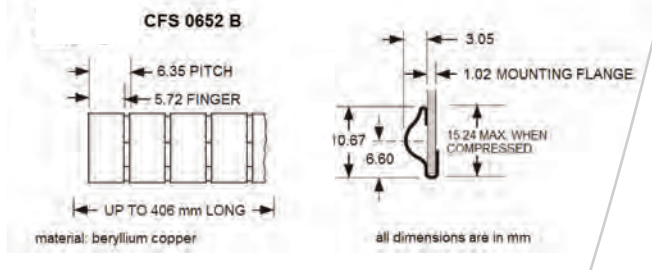
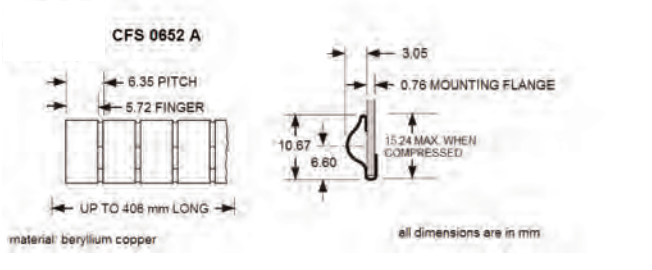
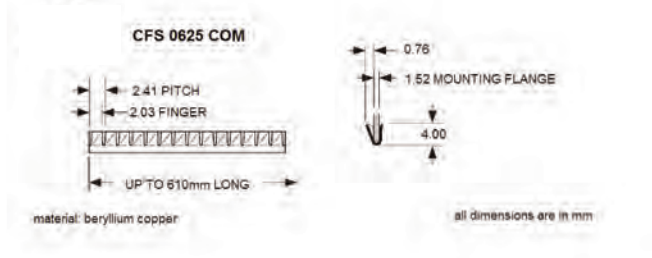
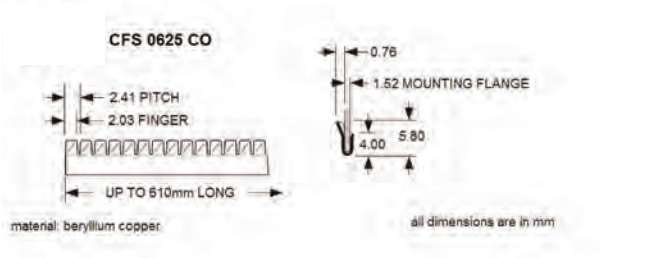
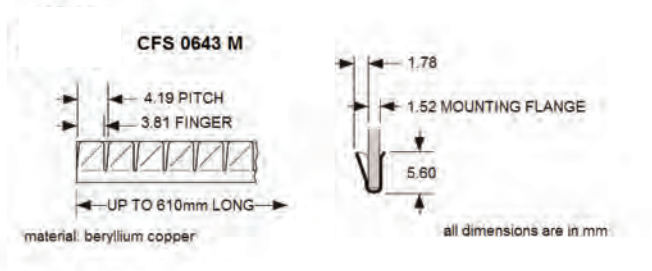
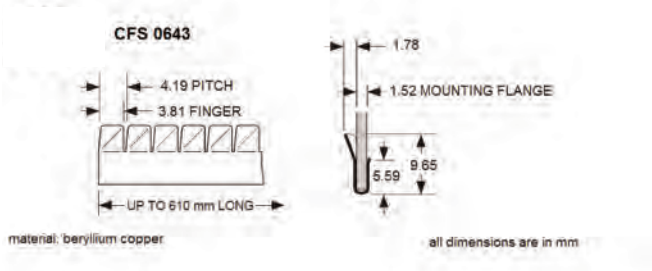
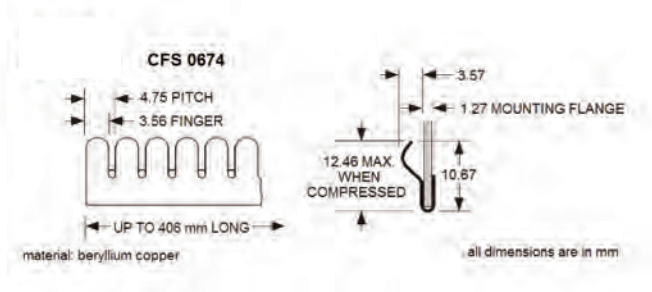
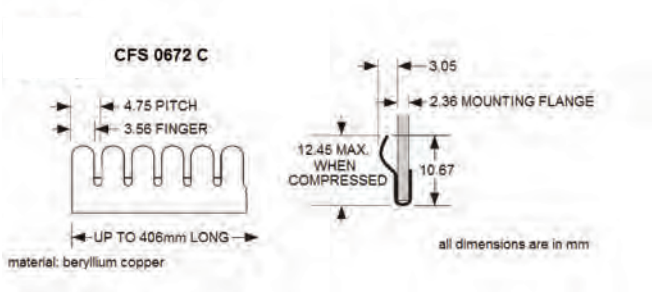
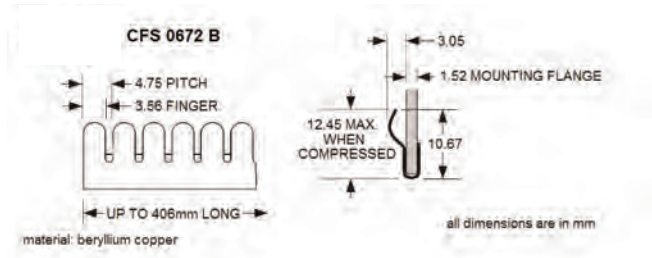
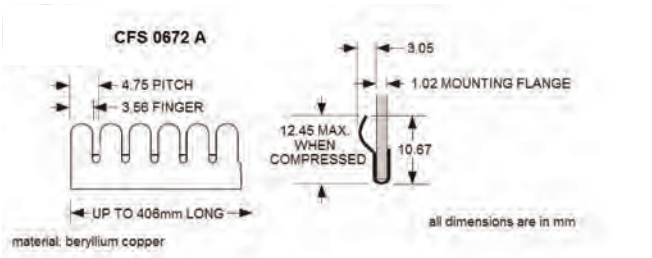

Nolato PPT
Unit 12 & 14
Maldon Trade Park The
Causeway, Maldon
CM9 4LJ

T: +44 1376 550525 w:
www.p-p-t.co.uk E:
sale.ppt@nolato.com

CONDUCTIVE FINGER STRIPS

CFS Shielding

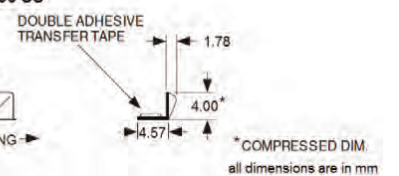
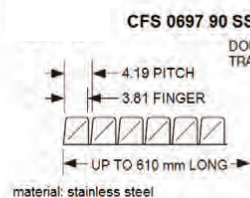
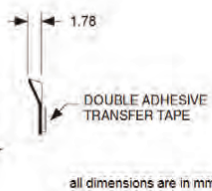
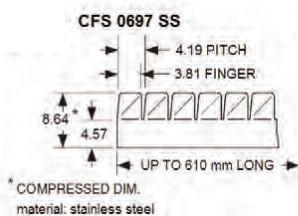
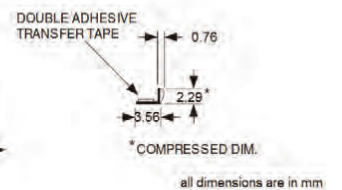
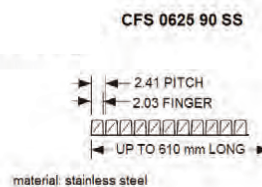
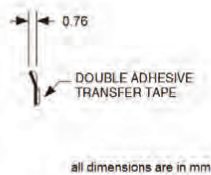
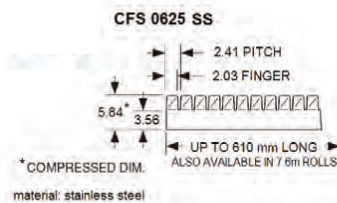
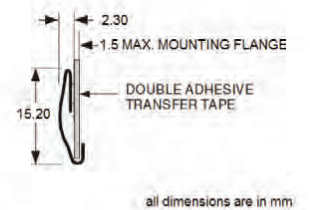
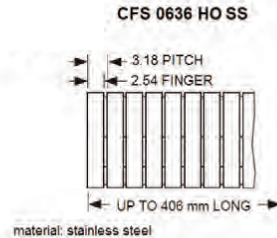
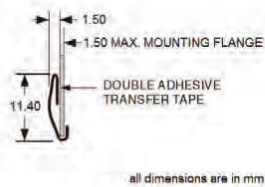
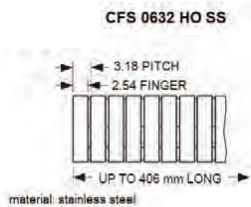
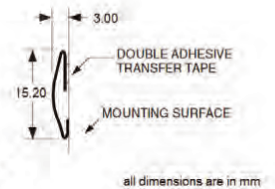
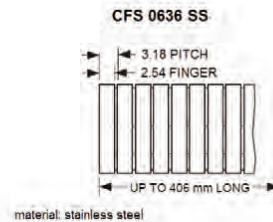
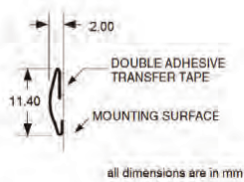
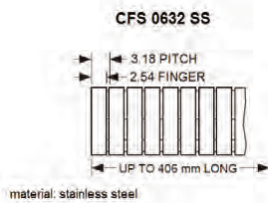
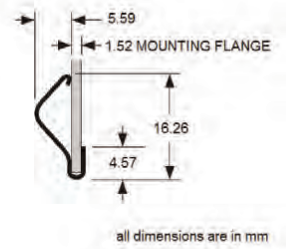
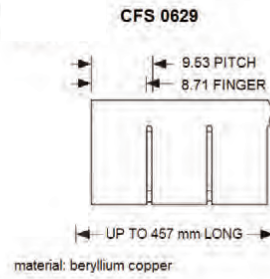
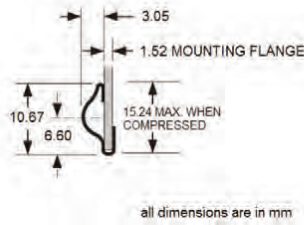
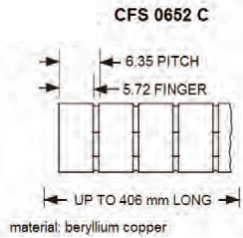

Nolato PPT
Unit 12 Maldon Trade park
The Causeway, Maldon
CM9 4LJ

T: +44 (0)1376 550 525
W: www.p-p-t.co.uk
E: sales.ppt@nolato.com

Our board level shielding cans are robust yet exceptionally precise; Quality is assured by an ISO 9002 management system which monitors all aspects of design, production, inspection and dispatch. All the raw materials are RoHS compliant. We offer both standard and custom sized cans.

SHIELDING CANS

PCB Shielding

Standard Shielding Cans:

Standard PCB mounted cans should be considered during board design. The matching of a standard solution to an already designed board will be difficult, in some cases, and impossible in others. During the design phase it is possible to design the board while considering the dimensions of a standard shield. This includes, leaving enough space on board for its placement, designing the grounding pad to fit the shield, selecting the suitable components, etc.

The advantages of ordering a standard product are that you save both time and money. These cans can be ordered in almost any quantity, with a minimum of 50 units. Each item has a datasheet which details size and mounting method.

Custom Shielding Cans:

Our custom shielding cans are made using an innovative CNC technology which enables us to offer our customers solutions for extremely low runs as well as mid-sized runs (around 5000 units) without the need for capital investments in tools. This unique manufacturing technique can support the production of complex designs while maintaining the durability and the stability of the shielding can. It also offers distinct cost advantages.

Instead of using etching techniques for prototypes and then tooling for medium to large scale runs, our shielding cans are made using a unique CNC punching technology for the production of both prototypes as well as medium-scale runs. The blanks are then processed by precision bending equipment giving the ability to deal with complex fabrication designs.

Compared to etching techniques which are limited to flat platen blanks produced from specific non plated material, this CNC technology enables the production of inline-formed elements such as tabs and ribs using pre-plated materials. This consequently reduces costs & lead-times, and improves product consistency through the transition to larger production.

Notes:

Stock materials include various brass and steel alloys, which are the most economical and popular solution for shielding. Other conductive materials are available.

All we require for quotation is a simple sketch with the dimensions of the product and method of mounting along with any packing considerations such as tape & reel or pick & place. (Large volume orders are supplied by default on trays.)

Please contact the sales office for further details.



Nolato PPT
Unit 12 & 14
Maldon Trade Park The
Causeway, Maldon
CM9 4LJ

T: +44 1376 550525 w:
www.p-p-t.co.uk E:
sale.ppt@nolato.com

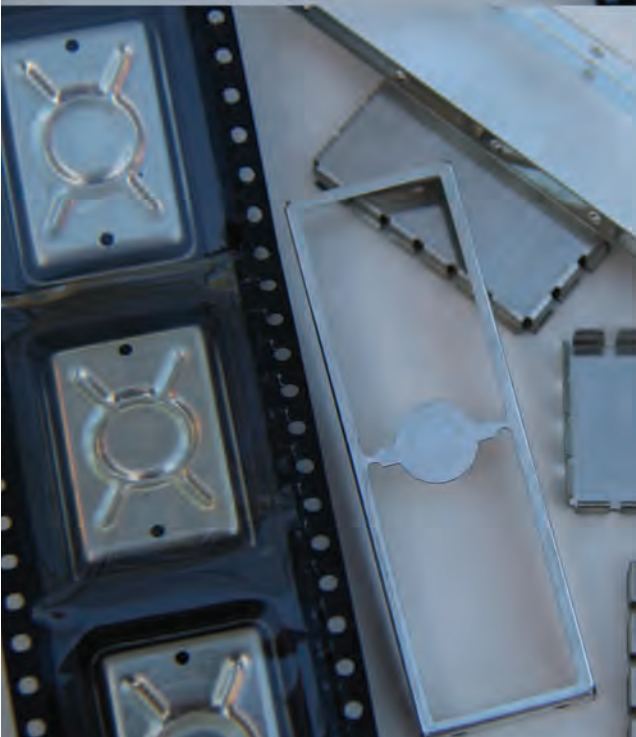
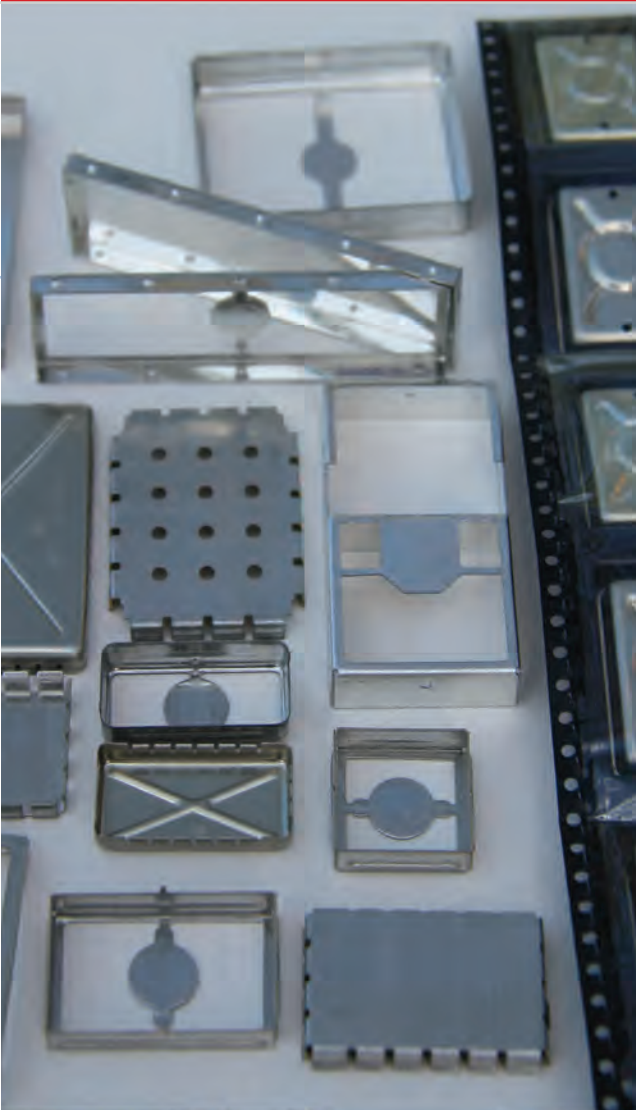

SHIELDING CANS

PCB Shielding

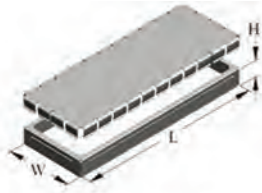

Spring Cover:

This very popular and traditional technique provides fixed repetitive pitched and conductive contact as well as convenient and easy removal. These covers can be fixed or locked onto their respective frames in a variety of techniques.

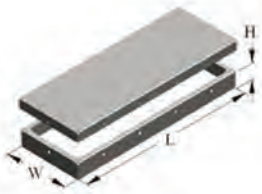

Dimple Cover:

Dimpling a cover provides both a locking device and a positive point of conductive contact. Both high and extremely low profile covers lend themselves dimpling.



Rimless:

As a general rule a small rim along the top of a shield provides significant stiffness enabling better handling and assembly. Occasionally components are too close to the shield wall to allow the rim, and in such cases the shield wall can be left shear. These shields can either be completely rimless or combined with rims.

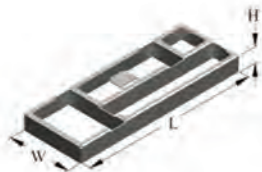

Multi Cavity:

When providing suitable shielding between densely mounted multifunctional circuitry, the most optimal solution is to use an integral fence partition fabrication, fitted with a matching cover. These shields take on a variety of shapes and designs depending on the resultant geometry of the circuitry.

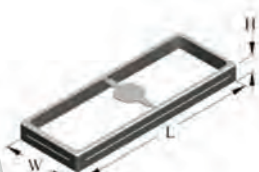

Drawn:

At higher frequencies the preference of RF engineers turn to more hermetically designed shields. Deep drawn cans provide a seamless protective cage. These shields can even be fabricated as drawn frames with drawn snap on covers. As opposed to bent frames these shields must be tooled.



Cover Only:

The most cost effective form of shielding. Covers are used on proven and highly reliable circuits since easy access is denied once soldered.

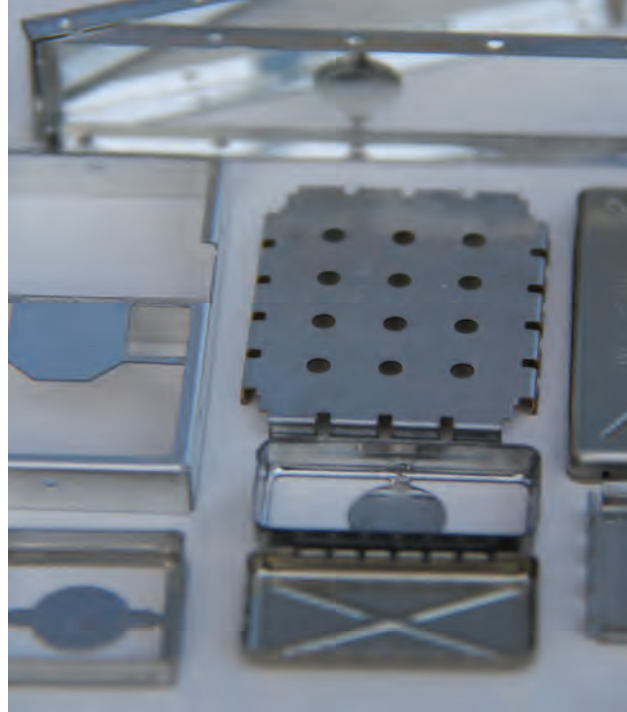

EXSHIELD | Conductive Silicone E Shielding

Our E Shielding gaskets are constructed from silicone containing metal powder fillers which combine to produce high levels of attenuation with excellent environmental shielding and a high level of conductivity. Many types of filler, from nickel graphite to pure silver, are available to suit a wide range of applications. There are also Fluorosilicone variants for use in the presence of hydrocarbon contamination.

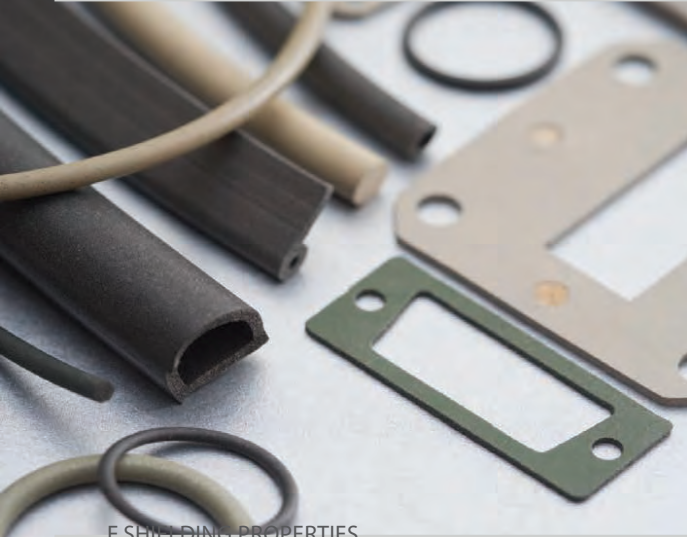

E SHIELDING PROPERTIES

Applications:

The Conductive Silicone Range was originally developed for high performance shielding mainly for military applications. However, the introduction of lower cost fillers has now made them accessible to the commercial sector. They are used where environmental and EMI screening is required but space constraints or stringent environmental protection necessitates a small cross section profile, often fitted into a groove or channel.

Conductively loaded silicone is best used where mating surfaces are smooth and well machined. They should be mounted to provide adequate volume for the material to deflect under pressure and should be compressed by between 8 and 20% of their relaxed height for solid sections and between 20 and 100% of the height of the hollow centre for tubular sections. Moulded 'O' rings, gasket profiles and sheet materials all have their own compression characteristics according to how they are mounted and do not comply with the guidelines above.

Specifications:

SERIES	EC-C	EC-Q	EC-J	EC-H	EC-S	EC-N	ECF-Q	ECF-J	ECF-H	ECF-N
CONDUCTIVE FILLER	Carbon	Nickel Graphite	Silver Aluminium (65)	Silver Copper	Silver	Nickel	Fluoro Nickel Graphite (70)	Fluoro Silver Aluminium	Fluoro Silver Copper	Fluoro Nickel
SHIELDING PERFORMANCE	STD 285 /MIL-DTL 83528C (db)									
10 MHz	30	115	111	115	117	114	116	114	116	110
100 MHz	65	121	120	122	126	115	122	122	125	116
400 MHz	60	119	120	119	121	121	119	118	118	124
1 GHz	N/A	122	121	123	130	114	122	121	124	117
2 GHz	40	122	119	122	129	122	122	123	121	112
6 GHz	N/A	115	115	116	121	117	114	109	117	111
10 GHz	30	114	112	115	118	114	107	114	115	113
18 Ghz	N/A	106	105	104	115	105	105	103	104	103
Operating Temp Range (°C)	+160 -50	+160 -55	+160 -55	+125 -55	+160 -55	+160 -55	+160 -55	+160 -55	+125 -55	+160 -55
Colour	Black	Dark Grey	Beige	Dark Tan	Beige	Grey	Green	Light Green	Green	Dark Green
Shore Hardness (A +/-5) ASTM D2240	60	60	65	65	75	65	65	70	65	70
Volume Resistivity (ohms) ASTM D991	2.2	0.04	0.008	0.005	0.002	0.1	0.05	0.01	0.005	0.1
Specific Gravity (+/- 0.25)	2.0	2.0	2.0	3.5	3.2	4.5	2.2	2.0	4.0	4.8

* the results and procedures provides data applicable only to the test enclosure & cover panel design, but which is useful for the making comparisons between gasket materials as stated in the MIL-DTL-83528C spec



Nolato

Nolato PPT
Unit 12 & 14
Maldon Trade Park The
Causeway, Maldon
CM9 4LJ

T: +44 1376 550525 w:
www.p-p-t.co.uk E:
sale.ppt@nolato.com

EXSHIELD | Conductive Silicone

EC Shielding



EC Shielding:

For conductively loaded silicone extrusions, a round or D section profile, fitted into a correctly dimensioned groove or channel will provide the most effective sealing and shielding performance. Fixing with any form of conductive adhesive is not recommended as this is likely to have an adverse effect on the environmental sealing.

How to order:

Standard sizes can be specified from the table below. Alternatively please provide a drawing of the profile required indicating series and filler.

SERIES	FILLER CODE	STYLE / SHAPE	SIZE
EC=Silicone	Q=Nickel Graphite	60=Solid Round	xxxx
ECF=Fluorosilicone	G=Silver Glass	61=Hollow Round	xxxx-xxxx
ECR=Flame Retardant*	J=Silver Aluminium	11=Solid 'D'	xxxx-xxxx-xxxx
	H=Silver Copper	12=Hollow 'D'	xxxx-xxxx-xxxx-xxxx
	S=Silver	13='U' Channel	xxxx-xxxx-xxxx-xxxx
*Nickel Graphite Only	C=Carbon	70=Rectangular	xxxx-xxxx
	N=Nickel	81=Solid 'P' Section	xxxx-xxxx-xxxx-xxxx
		82=Hollow 'P' Section	xxxx-xxxx-xxxx-xxxx

Example:

EC-J-61-0032-0016 is extruded tubular Silicone with Silver plated Aluminium filler of 3.2 mm o.d. and 1.6 mm i.d.

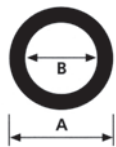

HOLLOW ROUND

DIM A (mm)	DIM B (mm)	PART NUMBER
2.40	0.80	61-0024-0008
3.18	1.14	61-0032-0011
3.96	1.27	61-0040-0013
6.35	3.18	61-0064-0032
7.92	4.88	61-0080-0048
9.53	6.35	61-0095-0064



SOLID ROUND

DIM A (mm)	PART NUMBER
1.02	60-0010
1.35	60-0014
1.57	60-0016
1.78	60-0018
2.03	60-0020
2.36	60-0024
2.62	60-0026
2.84	60-0028
3.02	60-0030
3.18	60-0032
3.30	60-0033
3.53	60-0035
3.81	60-0038
4.06	60-0040
4.78	60-0048
5.49	60-0055
6.35	60-0064



Nolato PPT
Unit 12 Maldon Trade park
The Causeway, Maldon
CM9 4LJ

T: +44 (0)1376 550 525
W: www.p-p-t.co.uk
E: sales.ppt@nolato.com

EXSHIELD | Conductive Silicone EC Shielding

**HOLLOW 'P'**

DIM A (mm)	DIM B (mm)	DIM C (mm)	DIM D (mm)	PART NUMBER
5.08	2.03	1.57	12.70	82-0051-0020-0016-0127
5.08	2.03	1.57	21.59	82-0051-0020-0016-0216
6.35	3.18	1.57	12.70	82-0064-0032-0016-0127
6.35	3.18	1.57	15.88	82-0064-0032-0016-0160
6.35	3.18	1.57	22.22	82-0064-0032-0016-0222
7.92	4.75	1.57	22.22	82-0080-0048-0016-0222
9.14	6.48	1.79	19.81	82-0091-0065-0018-0198

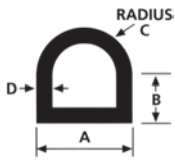
**HOLLOW 'D'**

DIM A (mm)	DIM B (mm)	DIM C (mm)	RAD R (mm)	PART NUMBER
3.96	3.96	1.14	1.98	12-0040-0040-0011-0020
4.75	4.72	1.27	2.36	12-0048-0047-0013-0024
6.35	6.35	1.65	3.18	12-0064-0064-0017-0032
7.92	7.92	1.27	3.96	12-0080-0080-0013-0040
7.92	7.92	1.57	3.96	12-0080-0080-0016-0040
12.37	8.23	2.03	6.20	12-0124-0082-0020-0062

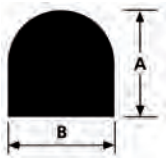
**SOLID 'D'**

DIM A (mm)	DIM B (mm)	PART NUMBER
1.63	1.40	11-0016-0014
1.73	1.57	11-0017-0016
1.98	2.39	11-0020-0024
2.26	1.98	11-0023-0020
2.54	1.57	11-0025-0016
2.79	3.81	11-0028-0038
3.43	3.10	11-0034-0031
3.96	3.00	11-0040-0030
4.45	4.52	11-0045-0045
4.78	4.78	11-0048-0048
6.35	6.35	11-0064-0064

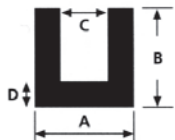
**U CHANNEL**

DIM A (mm)	DIM B (mm)	DIM C (mm)	DIM D (mm)	PART NUMBER
2.54	2.54	0.86	0.84	13-0025-0025-0009-0008
3.20	2.79	0.66	1.27	13-0032-0028-0007-0013
3.20	5.72	0.51	1.91	13-0032-0057-0005-0020
3.96	3.94	1.57	1.19	13-0040-0040-0016-0012
4.45	3.96	1.19	1.91	13-0044-0040-0012-0020
8.31	5.94	1.57	2.92	13-0083-0060-0016-0029



Nolato PPT
Unit 12 & 14
Maldon Trade Park The
Causeway, Maldon
CM9 4LJ

T: +44 1376 550525 w:
www.p-p-t.co.uk E:
sale.ppt@nolato.com

EXSHIELD | Conductive Silicone ES Shielding

ES Shielding:

ES Shielding is conductively loaded silicone which is produced in sheet form or as die-cut flat gaskets.

How to order:

Specify: *Series - Filler code - and Drawing Number or Size*

SERIES	FILLER CODE	P/N	SHEET SIZE
ES=Silicone	Q=Nickel Graphite	-1	50mm x 50mm
ESF=Fluorosilicone	G=Silver Glass	-2	100mm x 100mm
ESR=Flame Retardant Silicone	J=Silver Aluminium	-3	150mm x 150mm
	H=Silver Copper	-4	250mm x 250mm
	S=Silver	-5	300mm x 300mm
	C=Carbon	-6	400mm x 400mm
	N=Nickel	-7	430mm x 450mm

Example:

ES-J-0008-5 = Silver Aluminium 0.8mm x 300mm x 300mm



Nolato PPT
Unit 12 Maldon Trade park
The Causeway, Maldon
CM9 4LJ

T: +44 (0)1376 550 525
W: www.p-p-t.co.uk
E: sales.ppt@nolato.com

MAXSHIELD | Aluweave

GA Shielding

Aluweave is a versatile, highly conductive gasket medium produced by filling a woven aluminium mesh with silicone, fluorosilicone or neoprene rubber. It is particularly useful where thicker gaskets are unsuitable but, because it is woven, it is not viable for 'landwidths' of less than 3mm for die-cut gaskets. Surface irregularities should not exceed 0.05mm. This material is generally supplied as pre-cut gaskets constructed to the customer's specific requirements but can also be supplied in sheets. Connector gaskets in the DC Series include Aluweave materials.

Applications:

Aluweave is used for connector gaskets and other 'thin' gasket applications. If aluminium is unsuitable because of galvanic compatibility or shielding effectiveness, the expanded Monel based GX Shielding may be more appropriate.

Aluweave gaskets provide good 'point contact' where each crossover occurs, while the rubber filler ensures excellent environmental sealing. Aluweave, like nearly all other conductive gasket materials, should not be fixed with a conductive or pressure sensitive adhesive and should be fixed as a friction fit utilising the fixing screws to position the gasket before tightening.

Specifications:

Aluminium Mesh	AMS 4182A
Silicone Rubber	AMS 3220B
Fluorosilicone	MIL-R-25988
Neoprene	AMS 3222C

Temperature range:

Silicone	- 55 to + 250°C
Neoprene	- 40 to +107°C

Performance: Typical dB

FREQUENCY	FIELD	ATTENUATION
10 KHz	H	45
100 KHz	H	55
1 MHz	H	70
1 MHz	E	>100
10 MHz	E	>100
100 MHz	E	>100
400 MHz	P	100
1 GHz	P	69
10 GHz	P	50

How to order:

Specify: *Series - Filler Code - Thickness - Size or drawing number*

Example:

GA-SX-0005-Drawing No, specifies a cut gasket fabricated from 0.5 mm thick Silicone Aluweave

SERIES	FILLER CODE	THICKNESS	SIZE
GA=Aluweave	SX=Silicone	0005=0.5 mm	xxxx-xxxx
	SF=Fluorosilicone		
	NX=Neoprene		



Nolato PPT
Unit 12 & 14
Maldon Trade Park The
Causeway, Maldon
CM9 4LJ

T: +44 1376 550525 w:
www.p-p-t.co.uk E:
sale.ppt@nolato.com

MAXSHIELD | Monex GX Shielding

Applications:

Like Aluweave, Monex is used for connector gaskets and other 'thin' gasket applications. Mating surfaces should ideally be within $\pm 0.05\text{mm}$. Where hermetic sealing is not necessary, Monex NF is available without the silicone filler.

Monex gaskets provide good 'point contact', while the rubber filler ensures excellent environmental sealing. Monex, like nearly all other conductive gasket materials, should not be fixed with a conductive or pressure sensitive adhesive and should be fixed as a friction fit utilising the fixing screws to position the gasket before tightening.

Specifications:

Monel Foil	QQ-N-281B
Silicone Rubber	AMS 3220B

Temperatures:

Silicone	- 55 to + 250°C
----------	-----------------

Performance: Typical dB

FREQUENCY	FIELD	ATTENUATION
10 KHz	H	52
100 KHz	H	68
1 MHz	H	88
1 MHz	E	>100
10 MHz	E	>100
100 MHz	E	>100
400 MHz	P	100
1 GHz	P	84
10 GHz	P	42

How to order:

Specify: *Series - Filler Code - Thickness - Size or drawing number*

Example:

GX-SX-0005-Drawing number specifies a cut gasket fabricated from 0.5 mm thick Monex

Monex is an expanded Monel foil filled with silicone rubber. The exposed foil surface provides excellent conductivity combined with good corrosion resistance. Monex is also a 'thin' gasket medium, similar to Aluweave, and is particularly suitable for connector or waveguide gaskets where a pressure seal and EMI shield is required. The material cannot be effectively joined so gaskets should be cut in one piece wherever possible. Thicknesses of 0.5mm and 0.75mm are available and it can be supplied in sheet form.

To retain the strength of the foil, we recommend that a minimum land-width of 3mm should remain at any point around the edge of a Monex gasket. We also suggest that gaskets with intricate outlines are die-cut at the factory.

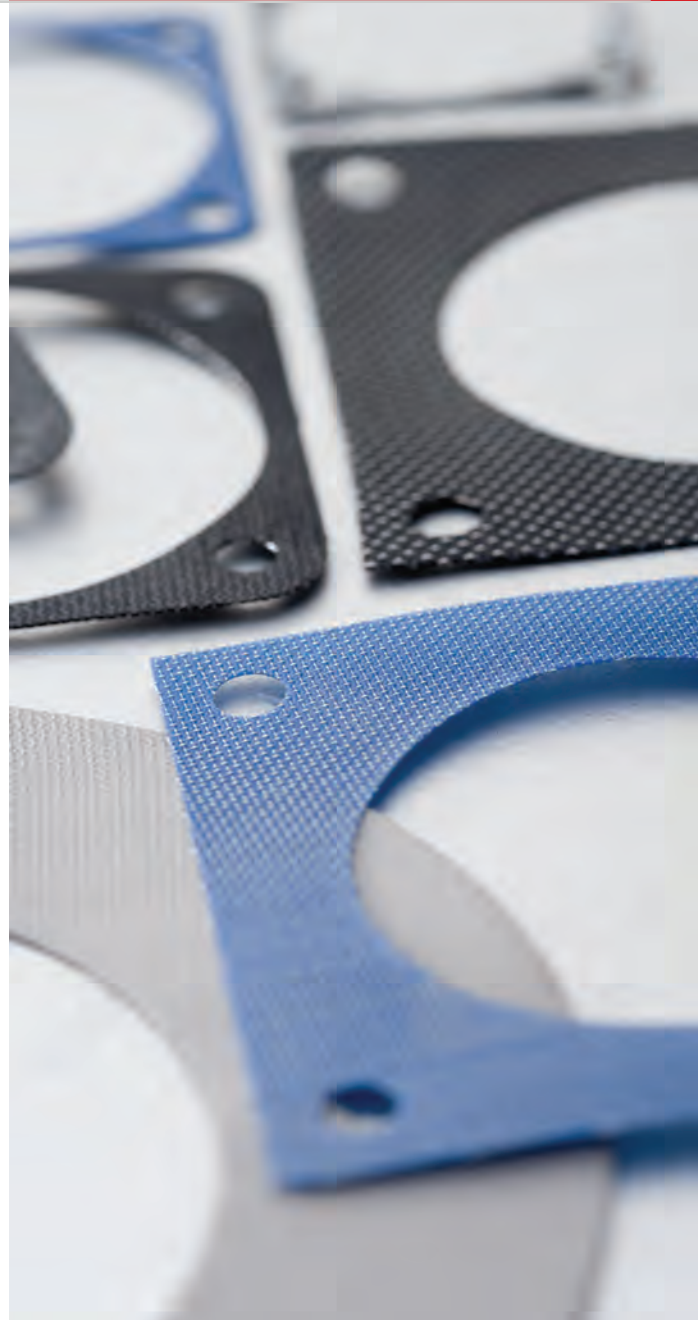

Nolato PPT
Unit 12 Maldon Trade park
The Causeway, Maldon
CM9 4LJ

T: +44 (0)1376 550 525
W: www.p-p-t.co.uk
E: sales.ppt@nolato.com

SERIES	FILLER CODE	THICKNESS	SIZE
GX=Monex	SX=Silicone	0005=0.5 mm 0007=0.75 mm	xxxx-xxxx

CONDUCTIVE FOIL TAPES

TF Shielding

Our range of conductive foil tape offers a cost-effective solution to EMC shielding. Tapes are available in both copper and aluminium with a conductive adhesive. The tapes can be used to seal joints on enclosures and for ground termination between panels on shielded rooms.

Bake & Peel Conductive Foil Tape:

Bake & Peel foil tape provides an effective alternative to selective plating or chromate conversion on painted surfaces.

The foil tape, which comes with a conductive adhesive backing, is fixed in place prior to painting. Once painting and baking are completed, the peel off mask can be removed to expose a conductive foil surface to which an EMC gasket can be fixed.

Temperature specification (baking) 1 hour at 200°C.



Specification:

PART NUMBER	DESCRIPTION	MATERIAL THICKNESS	ADHESIVE THICKNESS	PEEL ADHESION	ELECTRICAL RESISTANCE
TF-1000	Aluminium 'Bake & Peel' Tape	0.05mm	0.04mm	1060	<0.03 Ohms
TF-2000	Copper 'Bake & Peel' Tape	0.05mm	0.04mm	1080	<0.03 Ohms
TF-4000	Conductive Aluminium Foil Tape	0.05mm	0.04mm	1060	<0.05 Ohms
TF-5000	Conductive Copper Foil Tape	0.05mm	0.04mm	1050	<0.04 Ohms

How to order:

Specify: *Series - Part number*

SERIES	PART NUMBER
TF=Conductive Foil Tapes	1013=13mm wide Aluminium 'Bake and Peel' Tape
	1025=25mm wide Aluminium 'Bake and Peel' Tape
	2013=13mm wide Copper 'Bake and Peel' Tape
	2025=25mm wide Copper 'Bake and Peel' Tape
	4013=13mm wide Conductive Aluminium Foil Tape
	4025=25mm wide Conductive Aluminium Foil Tape
	4050=50mm wide Conductive Aluminium Foil Tape
	5013=13mm wide Conductive Copper Foil Tape
	5025=25mm wide Conductive Copper Foil Tape
	5050=50mm wide Conductive Copper Foil Tape

Example:

TF-1025 is 25 mm wide Aluminium 'Bake and Peel' tape.

Notes:

Standard roll is 25m for bake & peel versions.
Standard roll is 50m for plain foil versions.
Please contact us for preferred stock items.



Nolato PPT
Unit 12 & 14
Maldon Trade Park The
Causeway, Maldon
CM9 4LJ

T: +44 1376 550525 w:
www.p-p-t.co.uk E:
sale.ppt@nolato.com

CONNECTOR GASKETS

DC Shielding

Our range of connector gaskets includes precision die-cut gaskets made from a large selection of materials, both conductive and non-conductive. DC Shielding comprises waveguide and connector gaskets to MIL-C-81511, MIL-C-5015, MIL-C-38999 and MIL-C-26482 plus industry standard configurations including BN, BNC, D, WG, WR, IEC, UG, AN and special profiles cut to customers specifications.

Applications:

Generally connector gaskets are cut from thin reinforced materials, such as Aluweave or Monex, to ensure that the compressive forces exerted on the connector do not distort the gasket. However, for certain applications oriented wires in silicone or conductively loaded silicone are selected for their specific properties.

Most gaskets can be made from all standard materials but it is important to consider the 'land-width' around the periphery of a connector gasket if Aluweave or Monex are specified. In some instances, where a gasket has fixing holes on each corner, the holes are extended outwards to slots helping prevent damage to the gasket during production and fitting.

DC gaskets are fitted in the normal manner and particular care should be taken when passing a gasket over a threaded connector body. Avoid the use of conductive adhesives as they tend to adversely affect the sealing characteristics of most types of gasket.

Specifications And Performance:

The specifications, temperature ranges and shielding performance of each material type can be found in the relevant material sections.

How to order:

For AN connector gaskets specify the relevant part number from the table on the opposite page.

For all other waveguide and connector gaskets, state the material type and drawing number, MIL reference or standard specification as applicable or contact us to discuss your requirements.

Examples:

MC-312 = Shell size 12 in 0.5mm Silicone Aluweave

MC-210 = Shell size 10 in 0.75mm Silicone Monex

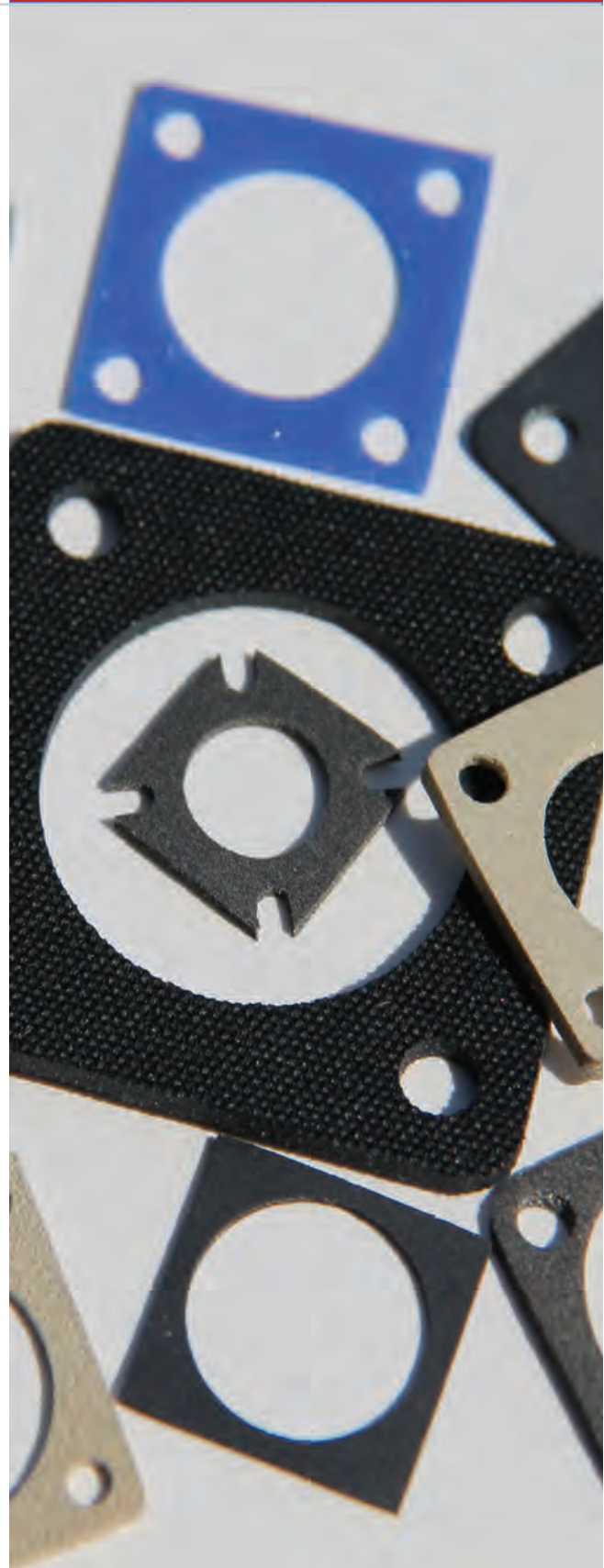

Nolato PPT
Unit 12 Maldon Trade park
The Causeway, Maldon
CM9 4LJ

T: +44 (0)1376 550 525
W: www.p-p-t.co.uk
E: sales.ppt@nolato.com

CONNECTOR GASKETS

DC Shielding

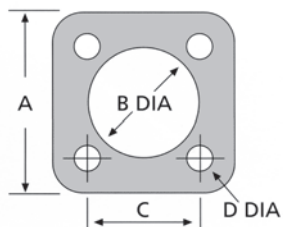

For some materials the holes will need to be extended to the edge to form U-shaped fixing points.

MIL-C-5015/26482 CONNECTOR GASKETS PART NUMBERS

AN SHELL SIZE	DIMENSIONS (mm)				PART NUMBER SUFFIX	PART NUMBER PREFIXES
	A	B	C	D		
8	22.23	12.70	15.09	4.5	08	MC-1 = Monex silicone 0.5mm
10	25.40	15.88	18.26	4.5	10	MC-2 = Monex silicone 0.75mm
12	27.79	19.05	20.65	4.5	12	MC-3 = Aluweave silicone 0.5mm
14	30.18	22.23	23.01	4.5	14	MC-4 = Aluweave neoprene 0.5mm
16	32.54	25.40	24.61	4.5	16	MC-5 = Silshield SP
18	34.93	28.58	27.00	5.0	18	MC-6 = Silshield SF
20	38.10	31.75	29.36	5.0	20	MC-7 = Exshield EC-Q
22	41.28	34.93	31.75	5.0	22	MC-8 = Silshield SR
24	44.45	38.10	34.93	5.5	24	MC-9 = Exshield EC-J
28	50.80	44.45	39.70	5.5	28	Other materials available on request
32	57.15	50.80	44.45	6.0	32	
36	63.50	55.58	49.23	6.0	36	
40	69.85	61.93	55.58	6.0	40	
44	76.20	70.64	60.33	6.0	44	
48	82.55	76.99	66.68	6.0	48	

MIL-C-38999 CONNECTOR GASKETS PART NUMBERS

SHELL SIZE	DIMENSIONS (mm)				PART NUMBER SUFFIX	PART NUMBER
	A	B	C	D		
9	24.10	16.50	18.26	3.5	09	EE10-75-38999-09
11	26.50	19.60	20.62	3.5	11	EE10-75-38999-11
13	28.90	22.80	23.01	3.5	13	EE10-75-38999-13
15	31.30	26.00	24.61	3.5	15	EE10-75-38999-15
17	33.70	30.90	26.97	3.5	17	EE10-75-38999-17
19	36.90	32.30	29.36	3.5	19	EE10-75-38999-19
21	40.10	35.20	31.35	3.5	21	EE10-75-38999-21
23	43.30	38.70	34.93	4.1	23	EE10-75-38999-23
25	46.40	42.00	38.10	4.1	25	EE10-75-38999-25



Nolato PPT
Unit 12 & 14
Maldon Trade Park The
Causeway, Maldon
CM9 4LJ

T: +44 1376 550525 w:
www.p-p-t.co.uk E:
sale.ppt@nolato.com

SILFILL CONDUCTIVE ADHESIVE

AS Shielding

Our AS Shielding one-part conductive particle filled silicone rubber adhesives are available using standard silicone and fluorosilicone base compounds combined with a selection of particle fillers to produce a readily extrudable paste which self-cures when exposed to atmospheric moisture. Once the thixotropic paste is fully cured it provides excellent adhesion and low volume resistivity.

Applications:

AS filled silicone adhesives are generally employed as caulking materials to fill voids, surface imperfections on mating surfaces or to retain a conductive gasket in position during assembly. Most conductive gaskets depend on flat, accurate and clean mating surfaces to provide a positive, low impedance bond and the additional use of conductive adhesives should be avoided wherever possible.

Shelf life is up to sixteen weeks (30ml, 55ml) or six months (71ml, 170ml, 310ml) if kept in the original packaging and stored in a dry atmosphere below 23°C.

AS adhesives should be injected under pressure if possible, and, where used as or with a gasket, should be retained under pressure whilst curing. This enhances the conductivity of the compound. Care should be taken when handling the compound as contact can irritate the skin and eyes.

Specifications:

Standard base rubber is silicone.

How to order:

Specify: *Series - Filler code - Tube size*

Example:

AS-N-030 is a 30ml cartridge of nickel-graphite filled silicone adhesive

Notes:

Some filler types may be subject to minimum order quantities.



SERIES	FILLER CODE	TUBE SIZE
AS=Silfill conductive adhesive	N=Nickel Graphite	030= 30ml cartridge
	J=Silver Aluminium	055= 55ml cartridge
	H=Silver Copper	071= 71ml cartridge
		170= 170ml cartridge
		310= 310ml cartridge



Nolato PPT
Unit 12 Maldon Trade park
The Causeway, Maldon
CM9 4LJ

T: +44 (0)1376 550 525
W: www.p-p-t.co.uk
E: sales.ppt@nolato.com

NON-CONDUCTIVE RUBBER AND GASKET KITS

RS Shielding

In addition to the manufacture of gaskets for electromagnetic shielding, we offer a wide range of non-conductive gaskets. These can be used in applications where an environmental seal against dust and/or liquid ingress is required. For ease of handling and storage, these can be supplied in complete labelled and bagged kits.

Gaskets can be die-stamped in complex shapes, with or without self-adhesive backing. Custom jointed O-Rings are also available.

Typical materials used are silicones, neoprene, EPDM etc. These are available in fire retardant variants to UL94-V0 and UL94-HF1. For ESD applications carbon loaded silicone is available. Gaskets can be cut from almost any form of rubber, fabric, foil or composite material to suit individual applications.



Applications:

Non-conductive gaskets, seals and gasket kits can be used as environmental seals in most types of enclosure. They are fitted in the same way as conductive gaskets and can be adhesive backed or combined with conductive materials to provide dual-purpose seals.

Specifications:

Individual material specifications are available on request. Contact us with your specification and we will source specific materials for inclusion in purpose built kits. Gasket kits can be created to customers own specifications to include almost any form of elastomer, fabric or composite materials, cut or stamped to suit individual applications.

How to order:

Please provide a detailed drawing indicating material required or contact us to discuss specific applications.



Nolato PPT
Unit 12 & 14
Maldon Trade Park The
Causeway, Maldon
CM9 4LJ

T: +44 1376 550525 w:
www.p-p-t.co.uk E:
sale.ppt@nolato.com

FREQUENTLY ASKED QUESTIONS

How does magnetic shielding work?

When magnetic lines of flux encounter high permeability material, the magnetic forces are both absorbed by the material and redirected away from its target. The most effective shields are constructed as enclosures such as boxes or cylinders with cap ends. The field follows the line of the enclosure so an enclosed shape keeps stray fields from finding gaps that could cause unintended interference.

What causes a magnetic field?

Most magnetic fields are man-made. They are found in solenoids, bar magnets and some motors and transformers. Magnetic fields are used in creative ways to create sound, microscopic images and record resonance images through MRI technology. In some cases, however, the fields interfere with sensitive electronic equipment and shielding is necessary.

What is Electromagnetic Interference?

Electromagnetic Interference (EMI) is electromagnetic energy that has an adverse effect on the performance of electrical/electronic equipment by creating undesirable responses or complete operational failure.

What is Electromagnetic Compatibility?

Electromagnetic Compatibility (EMC) is the ability of electrical or electronic equipment/systems to function in the intended operating environment without causing or experiencing performance degradation due to unintentional EMI.

Why do electromagnetic fields need magnetic shields?

EMI can be a problem for designers of many products. If we use mobile phones as an example, designers have to incorporate RFI shielding to stop unwanted RF emissions as well as to prevent other electrical equipment from interfering with the mobile phone operation. Designers may find that densely packed electronic assemblies may have internal components that interfere with each other, requiring electromagnetic shielding. When the EMI includes low frequency radiation, magnetic shielding is essential to assure proper operation of the electronic equipment.

What blocks magnetic fields?

There is no known material that blocks magnetic fields without it being attracted to the magnetic force. Magnetic fields can only be redirected, not created or removed. To do this, high-permeability shielding alloys are used. The magnetic field lines are strongly attracted into the shielding material.

Why must EMC be achieved?

Other than the fact that products that do not comply cannot be marketed legally in the EC, more disruptive manifestations would exist that could affect the very manner in which we lead our lives. These encompass health and safety issues, the security of data processing and the functioning of vital electronic equipment. ABS brake systems, engine management systems, telecommunications and data transfer plus the security of both commercial and military data could all be compromised without adequate screening.

Other issues, such as the dangers to health due to the emissions from mobile telephones and computer monitors plus ongoing research into the effects of living in close proximity to high voltage overhead power lines, all form part of the global concept of EMC. Some aspects can be easily controlled but others will continue to remain unresolved for years to come. The doomsday scenario of EMP (Electromagnetic Pulse) resulting from a high altitude nuclear explosion would certainly lead to the almost total loss of commercial communications and data processing plus much of the non-hardened military network, whilst at the same time avoiding the mass destruction of the infrastructure necessary for future use, possibly by the instigator of the blast.

In other words, without EMC being achieved, there would be potential chaos with no communications, services, power, media, such as TV and radio, and the loss of many forms of transport.

What are the main sources of EMI problems?

In all cases there has to be a source and a victim for a path to exist, thereby permitting a radiated or conducted coupling. Electromagnetic Interference (EMI), results from the operation of electrical or electronic devices involving rapidly changing voltage or current levels, which cause the generation of electromagnetic energy at discrete frequencies and over frequency bands.

Discounting natural sources such as atmospheric or lightning, conduction and radiation emitting sources include:

- Radar and communications transmitters
- Receiver local oscillators
- Computers and their peripherals
- Motors and switches
- Power lines
- Fluorescent lights
- Arc welders and many more.....



Nolato PPT
Unit 12 Maldon Trade park
The Causeway, Maldon
CM9 4LJ

T: +44 (0)1376 550 525
W: www.p-p-t.co.uk
E: sales.ppt@nolato.com

FREQUENTLY ASKED QUESTIONS

How can EMI be contained?

In simple terms, welding the equipment into a seamless steel box could solve most 'shielding' problems. The problems that this would lead to are obvious - access would be impossible, power unavailable, visibility would be zero and the equipment would rapidly overheat.

We have, therefore, to permit suitable penetrations of the shield to allow cables to pass in and out, to provide airflow and to facilitate the viewing of LED/LCD or CRT displays.

Enclosures for equipment are commonly made from steel, aluminium or, with increasing popularity due to its aesthetic design capabilities, plastic. Plastic enclosures should be coated with a metalised compound applied by vacuum deposition, painting or sputter coating. Alternatively, a lining of aluminium or copper foil can provide excellent shielding effectiveness.

In brief, the metal (or metalised) enclosure will, in most instances, require gaskets to seal mating surfaces and to provide the necessary low impedance electrical bond, attenuating vent panels for airflow and shielded windows to prevent the whole 'open' area where a display is mounted from representing an unacceptable gap in the shielding.

Inspection panels and doors can be fitted with 'soft-closure' gaskets or with contact finger strips (CFS) which also provide high shielding effectiveness with long service life and ease of closure.

Connectors for cable entry should similarly be fitted with gaskets and, where necessary, conductive cable glands to connect with screened cables if these are incorporated in the specification.

What is RFI?

Radio Frequency Interference (RFI) is considered part of the EMI spectrum, with interference signals being within the radio frequency (RF) range. This term was once used interchangeably with EMI. Conducted RFI is most often found in the low frequency range of several KHz to 30MHz. Radiated RFI is most often found in the frequency range from 30MHz to 10GHz.

What is the difference between RF and magnetic shielding?

Radio frequency (RF) shielding is required when high frequency - 100KHz and above - interference fields need blocking. These shields typically use copper, aluminium, galvanised steel or conductive rubber, plastic or paints. Because of their high conductivity and little or no magnetic permeability, these materials work at high frequencies. Magnetic shields use their high permeability to attract magnetic fields and divert the magnetic energy through themselves. With proper construction, magnetic shielding alloys have the ability to function as broadband shields, shielding both RF and magnetic interference fields.

What do I have to consider when deciding on the correct type of gasket?

Very often the design of the equipment enclosure will dramatically limit the choice of gasket materials. Some enclosures are lightweight aluminium or even plastic with very little potential for withstanding distortion during compression of the shielding gasket. Normally, the more robust the enclosure is the wider the range of materials that can be employed for gasketing. Similarly, wide and well reinforced flanges permit higher compressive forces particularly where limit stops are fitted.

Possibly the most difficult configuration for conventional shielding exists where a 'knife-edge' return on a door or cover is to mate with a conductive gasket, in addition to providing an environmental seal to IP55 or higher. If the enclosure can be modified to feature an additional return edge or flat where the knife-edge originally finished, the problem is easily solved but this is not always possible and is usually costly.

Also remember,

- Mating surfaces must be clean, flat, smooth and conductive (no paint, preservative, oil or grease should be visible).
- Ideal fixings are outside the shielded envelope and particular attention should be paid to screws/bolts passing through the enclosure to secure coverplates in position.
- Avoid gasket materials that are too hard for the type of enclosure.
- Avoid knife-edges wherever possible.
- Consider the environment and select gasket materials that are suitable and will not degrade, e.g. fluorosilicone rubber instead of plain silicone where hydrocarbon contamination is likely.
- Consider the operating temperature range.
- Do not over-engineer the design - the most expensive materials are not always the right ones for the job.
- Do not under-engineer to save money - this does not work in the long-term.
- Do not over-specify - 100dB may be comfortable but will 60dB solve the problem?
- Use standard or 'catalogue' products wherever possible.
- Consider the possibility of Galvanic Corrosion.

FREQUENTLY ASKED QUESTIONS

What effect can Galvanic Corrosion have?

What effect can Galvanic Corrosion have?

Where electrodes of two different metals are immersed in an electrolyte and externally connected by a conductive media, a 'battery' is effectively created whereby electrons will flow from one electrode to the other. According to the potential difference between the two metals, one electrode will become the donor electrode and will gradually be eroded.

The potential difference, or PD, of various metals commonly used in enclosures and shielding materials, and expressed in volts, is indicated in the table which follows based on the potentials against saturated calomel electrode in sea water:

MATERIAL	PD (VOLTS)
Zinc die-casting alloy	-1.10
Zinc plating on steel chromate passivated	-1.05
Cadium plating on steel	-0.80
Aluminium, wrought, cast Al Magnesium alloy	-0.75
Iron and steel: not corrosion resisting	-0.70
Duralumin	-0.60
Tin-plate (T.C.S)	-0.50
Iron and steel: corrosion resisting, 12%Cr	-0.45
Tin-plating on steel	-0.45
Chromium plating on Nickel-plated steel	-0.45
Iron and steel, corrosion resisting, High	-0.35
Copper and its alloys	-0.25
Nickel-copper alloys, incl. Monel	-0.25
Silver	0
Carbon (colloidal graphite in acetone)	+0.10
Gold	+0.15
Platinum	+0.15

The criteria most commonly employed to define a 'threat' is the likelihood of the equipment to be exposed to conditions of dampness or condensation due to wetting with salt water, salt mist/spray or the weather.

Where exposure is likely, the general rule of thumb regarding PD is as follows:

- Outdoor exposure or saltwater/spray contamination 0.3 volts
- Dampness or condensation without salt presence 0.5 volts

If the equipment is hermetically sealed and any exposed gasket edges are 'elastomer protected', i.e. with dual or twin gasket configuration there would be no restriction. Some combinations of metals, such as Silver (PD 0) and Aluminium (PD -0.75), have inherent problems. In these circumstances, gaskets should be totally enclosed or of 'twinstrip' construction.

Is additional protection available for sensitive components or circuits inside the equipment?

Quite simply, the best route to take is to utilise Circuit Board Shielding cans. These comprise a board-mounted 'fence' with a demountable cover or lid. The cover can be supplied with ventilation holes and cable-entry points if required. The fences can be supplied with several standard pin spacings and with or without stand-offs. Using Circuit Board Shielding can considerably reduce radiation and susceptibility problems, thereby making the overall shielding of equipment more cost-effective.



Nolato PPT
Unit 12 Maldon Trade park
The Causeway, Maldon
CM9 4LJ

T: +44 (0)1376 550 525
W: www.p-p-t.co.uk
E: sales.ppt@nolato.com

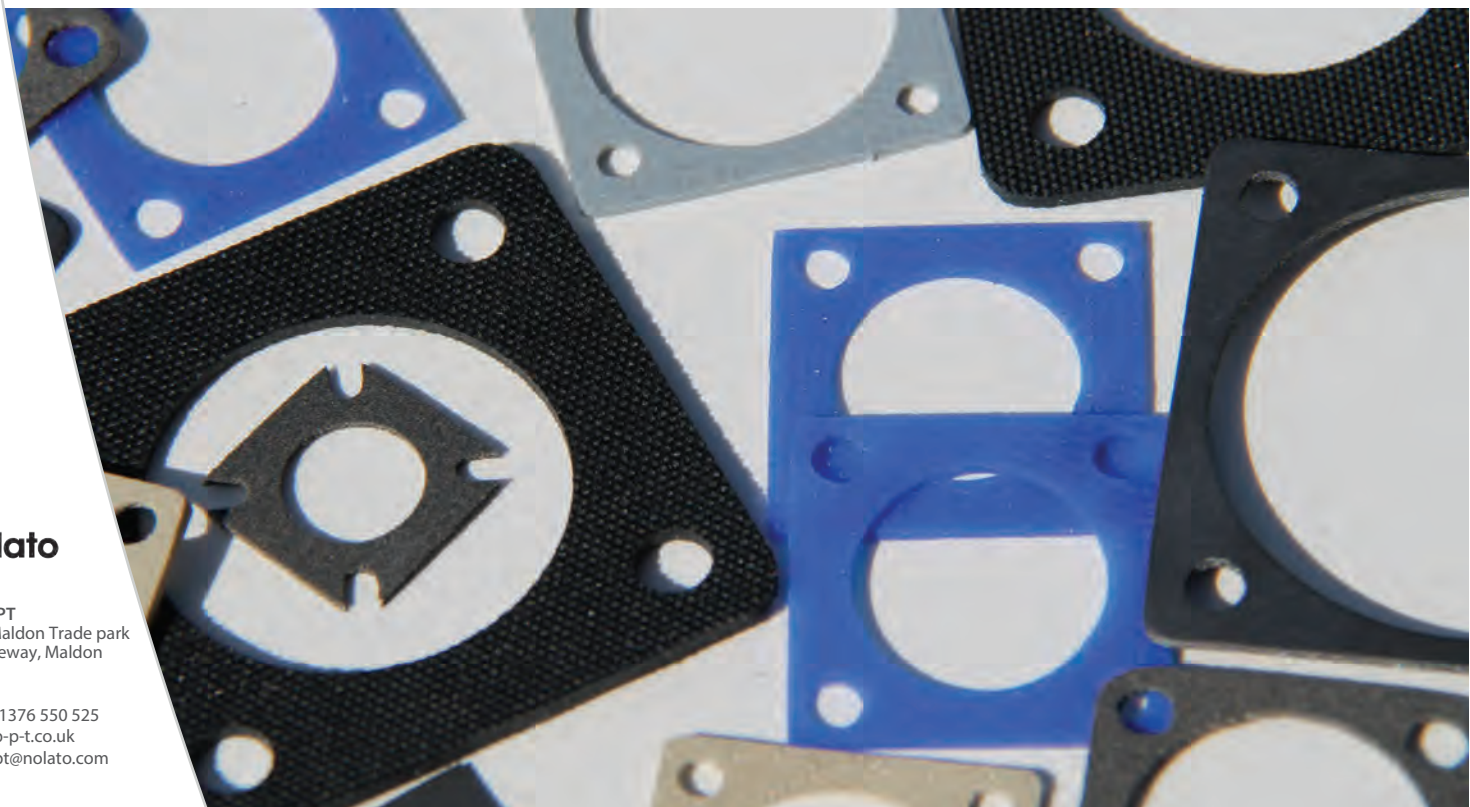



Product Catalogue

